



Type 140



Type 200



hybrid kitchen

- Multifunctional device for cooking, boiling, baking and cooling.
- A special functional door with separately regulated heating and fans gives the **hybrid kitchen** its special hybrid features.
- For system gastronomy.



Observe the operating instructions
Translation of the Original Operating Instructions

DOWNLOAD: USER MANUAL

QR code on type plate



Rieber Professional. Our solutions guarantee high quality, safety and, above all, excellent energy efficiency and cost effectiveness.

Contents

1	Revision Index	4
2	Important Information	4
2.1	Using this guide	4
2.2	Representation conventions in the text	5
2.3	Structure of safety instructions	5
3	General Safety Instructions	6
3.1	General behaviour	6
3.2	On use of electrical appliances	6
3.3	Operator's duties	7
3.4	Personnel qualification requirements	8
3.5	Personal protective equipment (PSA) must be readily available for personnel	8
3.6	Appliance-specific safety instructions	9
3.6.1	Safety and monitoring devices	9
3.6.2	Risks due to electricity	9
3.6.3	Risk of burns and scalds to hands, arms and face	10
3.6.4	Risk of stab wounds when handling the pointed temperature sensor	11
3.6.5	Transport	12
3.6.6	Warnings concerning the use of the appliance by children	12
3.7	Note the product identification and ensure its preservation	13
3.8	Information about regulations to be followed	13
3.9	Instructions on behaviour in an emergency	13
4	Purpose	14
5	Description of device	15
5.1	Designation	15
5.2	Technical data	16
5.3	Accessories	17
6	Before First Use	17
7	Use	19
7.1	Safety information with regard to use	19
7.2	Instructions for use	20
7.2.1	Switching on the appliance	20
7.2.2	Accessories	20
7.2.3	Filling	21
7.2.4	Core temperature sensor	21
7.3	The operating unit	22
7.3.1	Operating panel	22
7.3.2	Programs	23
7.3.3	Program settings	23

7.4	Programs	25
7.4.1	Cooking at chamber temperature	25
7.4.2	Cooking at core temperature	27
7.4.3	Fan	29
7.4.4	Hybrid - passive cooling and keeping warm	30
7.4.5	Cooking with 2 chambers	32
7.5	Keeping food warm (HOLD)	34
7.6	Display values	35
7.6.1	Chamber temperature	35
7.6.2	Core temperature	35
7.6.3	Time	35
7.6.4	Humidification with steam	36
7.7	Change during operation	36
7.8	Reset program (RESET)	36
7.9	Cancel program / Standby mode	37
7.10	Program end	37
7.11	Switch appliance off	37
7.12	Set date and time	38
7.13	Call up and save menu	39
7.13.1	Open menu	39
7.13.2	Save menu	42
7.13.3	Unlock menu with start time	44
7.13.4	Preinstalled menus	44
8	Cleaning, maintenance and care	45
8.1	Safety information relating to cleaning, maintenance and care	45
8.2	Cleaning agents for stainless steel	46
8.3	Choose the correct cleaning method	47
8.4	Overview of cleaning and maintenance intervals	48
8.5	Pump residual water out of the appliance, rinse the appliance	48
8.6	Cleaning	50
8.7	Descale the appliance as required	52
8.8	Keep ready for next use in dry condition	53
9	Troubleshooting	54
10	Index	56
11	Warranty and liability	57
12	Excerpt from the EU Declaration of Conformity	58
13	Contact address	59
14	Brief instructions	60

1 Revision Index

Revision	Change
2011-03-31	First issue
2011-05-06	Review of controls
2011-08-02	Change: Ending the program or switching off the device in real-time mode; Set date and time
2011-09-19	7.11.7 Note inserted referring to 2 different saving procedures
2012-08-03	Pictures replaced, layout #, warning icon
2015-10-07	Pictures with new captions; Structure edited; New naming; Safety method EC, TD, warranty
2017-07-24	HOLD function and pump function added

2 Important Information

2.1 Using this guide

This guide contains important information about how you can use the appliance safely and correctly.



- ▶ Read the operating instructions before first using the product.
- ▶ Keep this guide in a safe place and pass it onto the next owner should you wish to part with the product.

If there are any shortcomings in your opinion, please do not hesitate to let us know. With your help, we will try to become even better.

Please add your notes here 😊

2.2 Representation conventions in the text

Highlighting . . . Text fragment to be highlighted

- List
- Operating instructions



See '...' *Cross reference*



CAUTION

indicates potential damage to property without any personal injury.
Failure to follow these instructions may cause damage to property.



User tip

- ▶ Useful information or tip

2.3 Structure of safety instructions

The signal words DANGER - WARNING - CAUTION classify the degree of risk of bodily injury in an actual situation. You can avoid injury by complying with the behavioural rules provided.

The warning triangle symbol indicates a "General Danger".



DANGER

indicates **imminent danger**.

Failure to follow these warning instructions will result in **serious bodily injury or even death**.



WARNING

indicates a **potentially hazardous situation**.

Failure to follow these warning instructions **may cause serious bodily injury or even death**.



CAUTION

indicates a **potentially harmful situation**.

Failure to follow these warnings **may cause minor bodily injury**.

3 General Safety Instructions

This section covers residual risks and hazards associated with the intended use of the appliance. We have provided a list of all generally valid safety instructions which must be followed.

In the following section, safety information relating to a particular operation or situation is placed before the appropriate operation step or description of the situation.

3.1 General behaviour

This appliance meets the current state of the art and complies with all acknowledged technical safety-related regulations. Nevertheless hazards may still arise.

- Only use this appliance when it is in fault-free condition and according to the instructions in this user guide.
- In all of the device's life phases, make sure that it is safely integrated into its environment.
- Refrain from rearranging or changing the device.

3.2 On use of electrical appliances

Safety instructions according to EN 60745-1:

Work area

- Keep your work area clean and tidy. A messy or unlit work area can cause accidents.
- Keep children and other people away from the area when work is being carried out.

Electrical safety

- The power plug of the device fits into the socket. Do not modify the plug in any way. Never use an adapter in combination with earthed appliances. Using an unmodified plug and a suitable socket will reduce the risk of an electric shock.
- Avoid bodily contact with earthed surfaces such as pipes, heating units, cookers and refrigerators. The risk of an electric shock is greater when your body is earthed.
- Keep the device away from rain or wet. Allowing water to get into an electric appliance will increase the risk of electric shock.
- Do not use the cable for anything other than the intended purpose to disconnect the plug from the socket. Always remove whilst holding onto the plug. Keep the cable away from heat, oil, sharp edges or the moving parts of other appliances. Using damaged or tangled cables increases the risk of electric shock.
- When working with an electrical appliance outdoors, only use extension cables which are permitted for outdoor use. Using an extension cable suitable for outdoor use reduces the risk of electric shock.
- Potential risk of fire due to heat build-up. Unwind the cable from the cable drum to prevent a possible heat build-up and/or cable fire. The coupling must have splash protection, must be made of rubber or be rubber-coated.

Safety guidelines for persons

- Be alert. Be mindful of what you are doing. Take care when working with an electronic device. Do not use the appliance when tired or under the influence of drugs, alcohol or medication.
Just one moment of inattention whilst using the appliance can result in serious injury.

Careful handling and use of electrical appliances

- Never use an electrical appliance with a faulty switch. An electrical appliance which can no longer be switched on or off is dangerous and must be repaired.
- Keep unused electrical devices away from children. Do not allow the appliance to be used by persons who are not familiar with it or persons who are not familiar with this user guide. Electrical appliances are dangerous when in the hands of inexperienced persons.
- Treat the device with care. Check that moving parts are functioning properly and do not block; check whether parts are broken or damaged and impairing the functioning of the device. Have any damaged parts repaired before using the appliance. Many accidents are caused by poorly-maintained electrical appliances.
- Use electrical appliances, accessories etc in accordance with these instructions and in a manner that is specified for this particular appliance type. When using the appliance, please take into account the working conditions and the work being carried out. Using electrical appliances for other uses than that intended can lead to hazardous situations.

Service

- Only have the device repaired by qualified and authorised staff. Only use original spare parts. In this way you can ensure that the appliance remains safe.

3.3 Operator's duties

Operator

The operator is the person who operates the appliance for commercial or economic purposes either himself/herself or lets others use it and bears the legal appliance responsibility for protection of the user, staff or any third parties during operation.

Operator's duties

The appliance is used in commercial applications. For this reason, the operator of the appliance must meet all legal duties relating to work safety.

In addition to the safety instructions in this guide, the safety, accident prevention and environmental protection regulation applying to the application of the appliance must be complied with.

In particular, the following shall apply:

- The operator must be familiar with the applicable work safety regulations and identify, by carrying out a risk analysis, any additional hazards which are due to the place where the appliance is used. These hazards must be addressed in the form of operating instructions governing the operation of the appliance.
- Throughout the period of use of the device the operator must check that the operating instructions which he has compiled comply with the current regulations and adapt them if necessary.
- The operator must clearly regulate and define the responsibilities for installation, operation, troubleshooting, maintenance and cleaning.
- The operator must ensure that all employees who use the device have read and understood these instructions. In addition, the operator must train the personnel and inform them of the hazards involved at regular intervals.
- The operator must provide the personnel with the necessary protective equipment and issue mandatory instructions on wearing it.

In addition, the operator must ensure that the appliance is always in a perfect technical condition. For this reason, the following shall apply:

- The operator must ensure that the maintenance intervals defined in this guide are obeyed.
- The operator must regularly check all safety devices for functionality and completeness.
- The operator must ensure that the appropriate media connections are present.
- The operator must ensure that structural safety measures are performed.

3.4 Personnel qualification requirements

Safe operation requires certain technical skills and personal qualification of each person.

- The responsibility for organization lies with the '**Designated Representative**' (operator). According to EN 50110-1 a work supervisor is a person who is appointed to take direct responsibility for the performance of work. If necessary, this responsibility can be assigned partly to other persons. [...] The designated representative must instruct all persons involved in the work on all hazards which may not be obvious for them'.
- The work may only be performed by '**instructed persons**' who have been trained accordingly. Training, instructions must be repeated, proper understanding must be verified (ideally by way of an appropriate test).
- Only '**Qualified Staff**' are allowed to carry out repair work. IEC 60204-1 defines qualified personnel as "persons who, on account of their training and relevant experience are in the position to recognise risks and avoid potentially dangerous situations."
- Electrical work may only be carried out by trained and experienced **electricians**. Electro-technically instructed persons may only work under the supervision of a qualified electrician.
- The housing of the circulating air heater may only be opened/closed for the purpose of thorough cleaning by appropriately trained and authorised operating personnel (qualified electrician). This is only permitted by the manufacturer's service department during the guarantee and warranty period.
- Any repairs and/or overhaul during the warranty period may only be carried out by the manufacturer's service department.



'Warranty and liability', page 57

3.5 Personal protective equipment (PSA) must be readily available for personnel

- Ensure that the personnel wear the personal protective equipment appropriate to the relevant situation.
- Wear sturdy shoes to avoid injury when transporting the appliance.
- Wear protective gloves to avoid burns and scalds to hands and arms.

3.6 Appliance-specific safety instructions

This chapter describes general, appliance-specific safety instructions. In the following section, additional safety information relating to a particular operation or situation is placed before the appropriate operation step or description of the situation.

3.6.1 Safety and monitoring devices

- The device features a safety cut-out. The product switches itself off automatically in the event of a fault in the control system.
- To increase your safety we recommend that you install a residual current device with a tripping current of 30 mA upstream of the appliance.



The door lock has two levels for safety reasons.

When the door lock is first pulled, the door opens by around 1 cm, so that any overpressure can escape in the form of hot air or steam.

When it is pulled a second time, the door can be fully opened.

3.6.2 Risks due to electricity

➤ **⚠ WARNING**

Danger of electric shock. Risk of death.

Keep mains cable away from hot parts like the circulating air heater. The mains cable is temporarily resistant to contact with hot parts. A damaged mains cable must be replaced by a qualified electrician.

➤ **⚠ WARNING**

Danger of electric shock. Risk of death.

Keep the appliance away from rain or moisture. Allowing water to get into an electric appliance will increase the risk of electric shock.

Risks when transporting open liquids and food. Liquid could penetrate the circulating air heater.

- Only transport liquids and food in closed containers.
We recommend: Use Gastronorm containers and thermoplates[®] with watertight press-in lids from Rieber.
- Always disconnect the power cable before transporting the appliance; use the mains plug to do this.
- Install the electric cable in such a way that risks like falling over or tearing off the cable, etc. are avoided.

Risks due to soiled circulating air heater.

- Do not poke anything into the ventilation grille.
- The heater housing may only be opened/closed for the purpose of thorough cleaning by appropriately trained and authorised operating personnel (qualified electrician). If necessary, contact the manufacturer's service department.



See 'Personnel qualification requirements', page 8

- Before each use, inspect the product, the connecting plug and electric cable for any visible signs of damage.
- The socket outlet must be easily accessible so that the unit can be disconnected from the power supply at any time.
- Compare the connection data on the type plate with the data of the electrical network before connecting (voltage and frequency, power rating).
- Connect the appliance to the socket with an upstream residual current device (RCD) with a tripping current of 30 mA.
- Protection class IPX5. Never direct a jet of water at electrical components such as heater, controller or ventilation grille. Protection against penetrating moisture is required.



Also refer to „On use of electrical appliances“; Page 6

3.6.3 Risk of burns and scalds to hands, arms and face

The temperature inside the appliance can be **up to +200 °C**.

- Be careful.
- When opening the door using the two-stage door lock allow steam to escape first of all, then open completely.
- Wear personal protective equipment such as protective gloves.
- Keep flammable materials away from the product.

3.6.4 Risk of stab wounds when handling the pointed temperature sensor



WARNING

Risk of stab wounds when handling the pointed core temperature sensor.

- ▶ Be careful.
- ▶ Keep the core temperature sensor in the holder on the inside of the door.

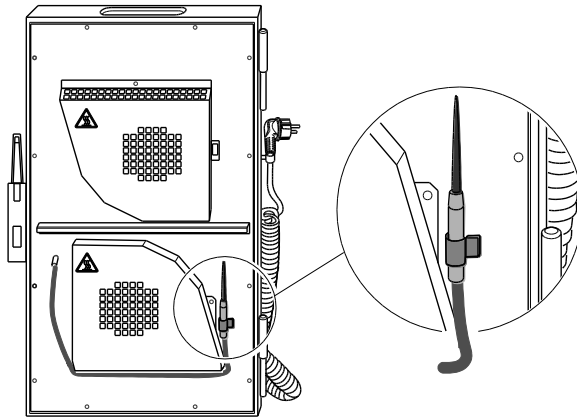

CAUTION

When inserting the core temperature sensor into the ventilation grille of the circulating air heater, the heater could be damaged; substantial damage to the appliance is possible.

- ▶ Keep the core temperature sensor in the holder on the inside of the door.

3.6.5 Transport

When transporting the device with **about 69 kg** empty weight, there are considerable risks of being crushed. When loaded with tableware and food, this risk increases.

- Observe the **permissible load of 110 kg**. Do not place any objects on top of the appliance.
- Disconnect the connection cable.
- Do not pull **the appliance**, only **push it**. This ensures good visibility and direct access to the casters with brakes.
Keep the door closed during transport and push the appliance by the handle. Wear sturdy shoes to avoid injuries.
- Transport the appliance on a level surface.
- Secure the appliance against inadvertently rolling away with the 'parking brake'.
- Wear safety shoes to prevent injuries.



CAUTION



Uneven ground such as edges, ridges or thresholds can damage the castors.

- Only move the appliance over flat, smooth surfaces. Do not push or pull the appliance over sharp edges.
 - Note the permissible step height, maximum 4 mm, otherwise the casters might be damaged.
 - Do not use this appliance on poor floor conditions.
We are not able to rule out the possibility of marks appearing on the floor due to friction with castors or the formation of scratches due to split cracks in the castors, for example.
-
- Mobile appliances may only be moved manually. Machine-aided transport, e.g. using fork lift trucks or lift trucks, is not permissible.

3.6.6 Warnings concerning the use of the appliance by children

- This appliance may be used by children over 12 and by persons with limited physical, sensory and intellectual abilities or a lack of experience and/or knowledge if they are supervised or if they have been instructed in the safe use of the appliance and have understood the resulting dangers. There is a risk of suffocation if locked into the appliance.
- Children may not play with the appliance.
- Cleaning and user maintenance may not be carried out by children without supervision.

3.7 Note the product identification and ensure its preservation

	<p>The type plate bears the legally required product data. → Type plates are on the bottom of removable door and the appliance itself.</p>
	<p>Warning of hot surface → on the removable door, top → on the top or lid of the appliance → on the inside of the removable door in the area of the heating units</p>
	<p>Do not store the core temperature sensor in the ventilation grille of the circulating air heater; note about possible material damage. → on the removable door, top</p>

3.8 Information about regulations to be followed

In addition to this user guide there are a range of health and safety and other regulations that are relevant for the operation of this cooking station; these include HACCP food hygiene regulations for example.

3.9 Instructions on behaviour in an emergency

- In an emergency the power supply must be cut off immediately.

⚠ First Aid for burns, scalds, cuts and electric shock

- Inform yourself on this before commissioning the appliance.
- Keep utensils for emergencies and instructions in an easily accessible place close to the place of use.



User tip

- ▶ Inform yourself in details by reading the in-house operating instructions.
- ▶ We recommend practicing emergency procedures every six months.

4 Purpose

This chapter provides information on the intended use of the product and warns against foreseeable misuse or abuse, for your safety.

Use the appliance only for its generally intended use.

⚠ Generally intended use means:

- For system catering, catering, hotels, restaurants and school cafeterias.
- For cooking, core temperature cooking and regeneration of food, specially portioned foods and for keeping food warm or cooling.
- The nominated person with responsibility for the appliance, e.g. the master chef, programs the appliance settings.
- Wear personal protective equipment such as protective gloves. This helps avoid burns to the hands and arms from hot objects such as heating elements, appliance parts and food.
- The intended use includes compliance with the technical data.
- For use only by appropriately trained and suitable operating personnel.

⚠ Prevent any predictable misuse and abuse. This means:

- Do not operate the appliance unsupervised. To prevent persons from burning themselves on hot surfaces, use of the product in public, e.g. for self-service, should only be allowed under supervision.
- Remove the protective sheath on the tip of the core temperature sensor before first use, otherwise there is a risk of significant damage and malfunction.
- Do not insert the core temperature sensor in the grille of the circulating air heater on the inside of the door.
- Not intended for private use at home.
- Do not lean against or sit on the appliance.
- Keep any combustible or explosive fluids away from heated appliances. Otherwise a fire or explosion may occur.
- Do not use to heat up a room.
- Do not pull or push the appliance over sharp edges, danger of material damage.
- Do not use this appliance on poor floor conditions. Otherwise, the floor can be damaged due to wear and tear to the casters or sustain scratches due to cracks in the casters.
- Be aware of the permitted step height of max. 4 mm. otherwise the castors may be damaged.
- Mobile appliances may only be moved manually. Machine-aided transport, using fork lift trucks or lift trucks, is not permitted.
- Only fill the water tank with drinking water.

5 Description of device

This chapter has interesting facts about the set-up and functionality of this appliance

5.1 Designation

All parts are named here to facilitate further understanding of the manual.

- 1 Corner bumper
- 2 Take-up → for accessories for type 140
- 3 Caster
- 4 Electric heating with fan, top
- 5 Electric heating with fan, bottom

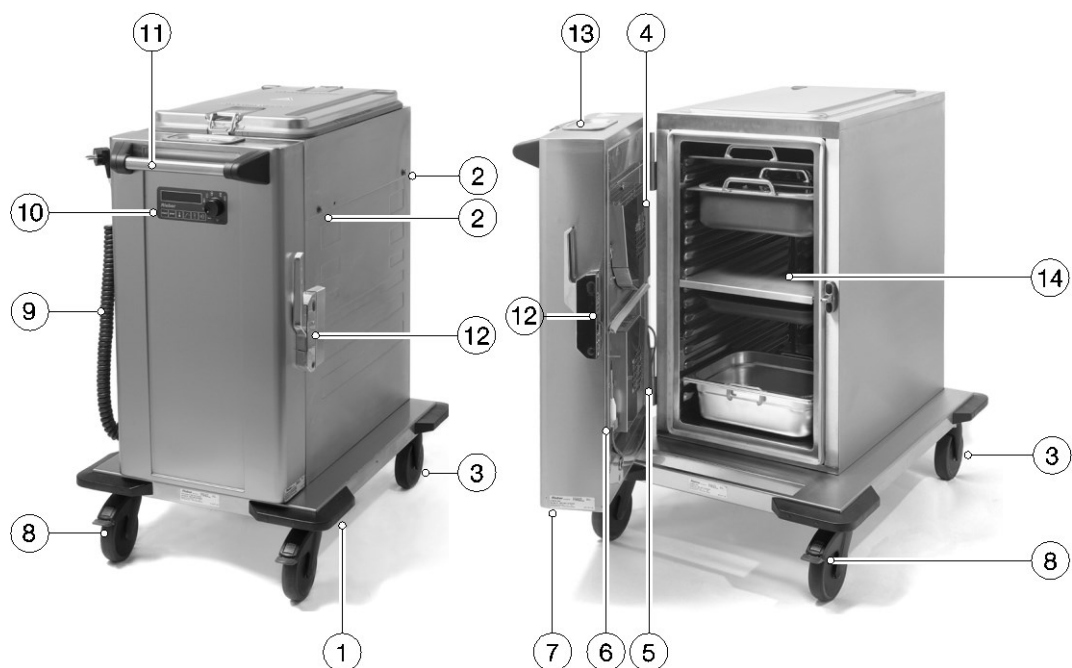

Operating and display elements

- 6 Core temperature sensor in the support
- 7 Lockable door, removable
- 8 Caster with parking brake
- 9 Electrical connector
- 10 Operating unit → to operate the appliance
- 11 Handle
- 12 Door lock
- 13 Water container with lid
- 14 Insulated divider

5.2 Technical data

	hybrid kitchen 140	hybrid kitchen 200
Outer dimensions (L x W x H), ca.	592 x 821 x 960 mm	662 x 870 x 981 mm
Temperature range	up to +140 °C	up to +200 °C
Empty weight, ca.	61 kg	69 kg
Permissible loading	110 kg	
Electric connector	1N AC 230 V 50/60 Hz with extendable spiral cable, 2.5 m, with shockproof plug and dummy plug	
Electrical fuse	16 A: Connect the unit on site to a socket with an upstream residual current device (RCD) with a tripping current of 30 mA.	
Power	3.5 kW	
Protection class	IPX5 as per DIN EN 60529 (Protection against spray water, jet, from any angle). → Affects the electric parts in the removable door	
Maximum filling capacity	Ca. 78 litres, sufficient for ca. 60 people. The interior of the container is intended to accommodate GN containers, max. 2 x GN1/1 (325 x 530 mm), 200 mm deep and 1 x GN1/1, 150 mm deep or subdivided.	
Support rails	16 pairs (seamlessly deep-drawn)	
Impact protection	4 corner bumpers at floor of appliance	
Casters for mobile version	Galvanised in accordance with DIN 18867, Part 8, wheel diameter 125 mm, 2 casters with parking brakes and 2 casters, antistatic tyres	
Housing	Chrome-nickel steel, material no. 1.4301	
Water tank, ca.	0.5 litres	
Hygiene version	H2	H3
Permitted ambient conditions	+5°C to +40°C. Carcass with double-wall insulation	
Emission sound pressure level, appliance closed	54 dB	48 dB
Emission sound pressure level, appliance open	66 dB	67 dB
Order no.:	85 01 09 04	85 01 09 11

Detailed specifications for measurements, order number, accessories, circuit diagrams, spare parts, wear and tear parts:



[See catalogue/brochure](#)

➤ If you have any questions, please contact your local Rieber Service.

5.3 Accessories



User tip

With the optimal accessories, you can achieve a high level of energy efficiency and extend the possible applications.

- ▶ Use varithek[®]-cooking utensils - **thermoplates**[®] from Rieber GmbH & Co. KG.



See <http://www.rieber.de>

6 Before First Use

This chapter describes the measures to be taken before use.

Check/handle any transport damage

- Immediately after delivery, visually check the appliance for any transport damage.
- Document the damage on the freight slip while the transport operator is present and have him provide his signature.
- Decide if you wish to keep the appliance and report the defect using the consignment note, or if you wish to reject the appliance.

■ By following this procedure you will ensure proper claim settlement.

Unpacking

- Open the transport packaging at the positions provided for this purpose. Do not tear or cut.
- Remove any packaging remnants.

Scope of delivery

- Check the scope of delivery.

Dispose of packaging material

- Dispose of packaging material in a proper and environmentally compatible manner.



CAUTION

Protective foils or heat-sensitive objects at/in the appliance might damage the appliance during heating.

- Ensure that there are no **protective foils** on the inside or outside of the appliance.
- Remove the protective sleeve on the tip of the **core temperature sensor** before first use.

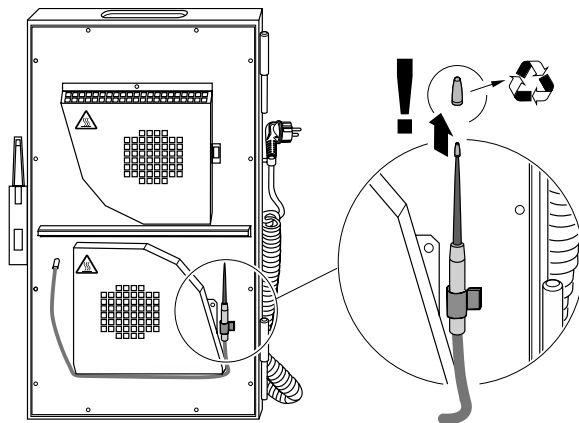

Transport device

➤ **CAUTION**

Do not use this appliance on poor floor conditions.



Chapter 'Transport', page 12

Clean the appliance



See chapter 'Cleaning', page 50 ff.

7 Use

7.1 Safety information with regard to use

Keep to the basic rules for operating the product

- The installation conditions such as lighting, safe positioning, free access are complied with.
- Use the two parking brakes to prevent the device from rolling away accidentally. Only park the device on flat surfaces.

 *Chapter 'Transport', page 12*



Avoid risks from electricity

WARNING

Danger of electric shock. Risk of death.

Keep mains cable away from hot parts like the circulating air heater. The mains cable only has limited resistance to contact with hot parts. A damaged mains cable must be replaced by a qualified electrician.

WARNING

Danger of electric shock. Risk of death.

Keep the appliance away from rain or moisture. Allowing water to get into an electric appliance will increase the risk of electric shock.

- Connect the unit on site to a socket with an upstream residual current device (RCD) with a tripping current of 30 mA.
- Never direct a jet of water at electrical components such as heater, controller or ventilation grille. Protection against penetrating moisture is required.

Risks from hot steam and hot surfaces

WARNING



Risk of **scalds** from hot steam and **burns** on hot parts to hands, arms and face.

The temperature inside the appliance can be up to +200 °C.



- ▶ When opening the door, take a step back and wait until the steam has evaporated.
- ▶ Wear personal protective equipment i.e. protective gloves.

⚠ Risk of stab wounds when handling the pointed core temperature sensor

➤ **⚠ WARNING**

Take care when handling the pointed core temperature sensor. Keep the core temperature sensor in the holder on the inside of the door.

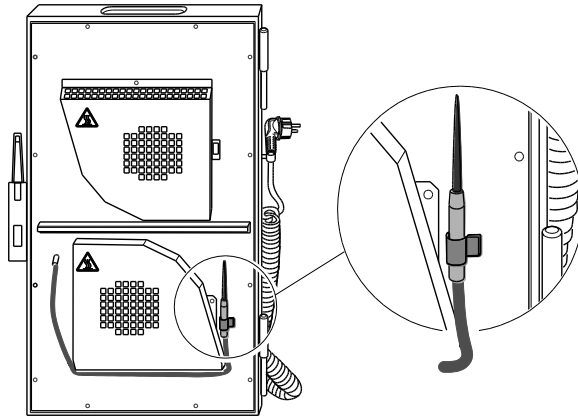

7.2 Instructions for use

7.2.1 Switching on the appliance

- Pour drinking water into the water tank, **up to a maximum of 1 cm below the top, ca. 0.5 l.**
- Make sure there is always drinking water in the tank. **Top up the drinking water regularly.** No error message is given when there is no drinking water in the container.
- Insert plug.
 - The standby display lights up.

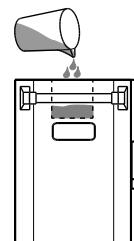

7.2.2 Accessories

i User tip

With the optimal accessories, you can achieve a high level of energy efficiency and extend the possible applications.

- ▶ Use varithek[®]-cooking utensils - **thermoplastes[®]** from Rieber GmbH & Co. KG.
 - Store, prepare, cook, barbecue, boil, portion and serve from a single container.

7.2.3 Filling

- Users' tips on loading the **hybrid kitchen** can be found online at



see“ http://www.rieber.de/uploads/tx_commerce/Rieber_Hybrid_kitchen_deutsch_01.pdf“

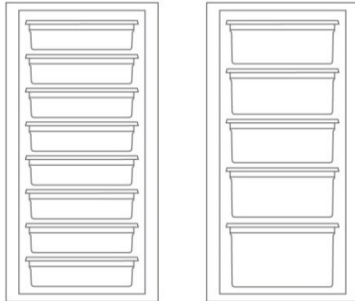

8 x GN 1/1 65 mm deep

4 x GN 1/1 100 mm deep

1 x GN 1/1 150 mm deep

- Whenever possible leave some free space in the **hybrid kitchen** . The air must be able to circulate.
- Immediately after loading the **hybrid kitchen** , close it and do not open it until directly before issuing.
- After removal, close the door/lid immediately.

7.2.4 Core temperature sensor



CAUTION

Do not put the core temperature sensor into the ventilation grid, otherwise the ventilator could sustain damage.

- ▶ Keep the core temperature sensor in the holder on the inside of the door.

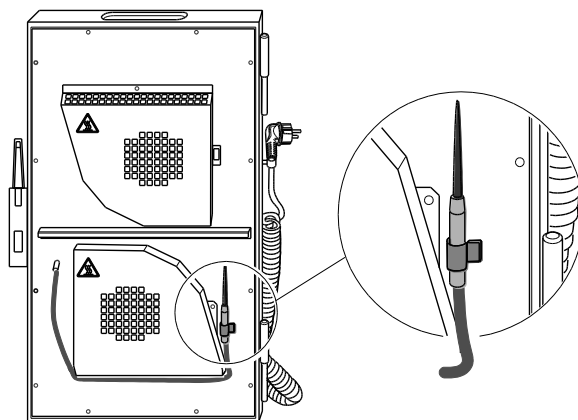

- After using the core temperature sensor, clean it with a damp cloth.

7.3 The operating unit

7.3.1 Operating panel

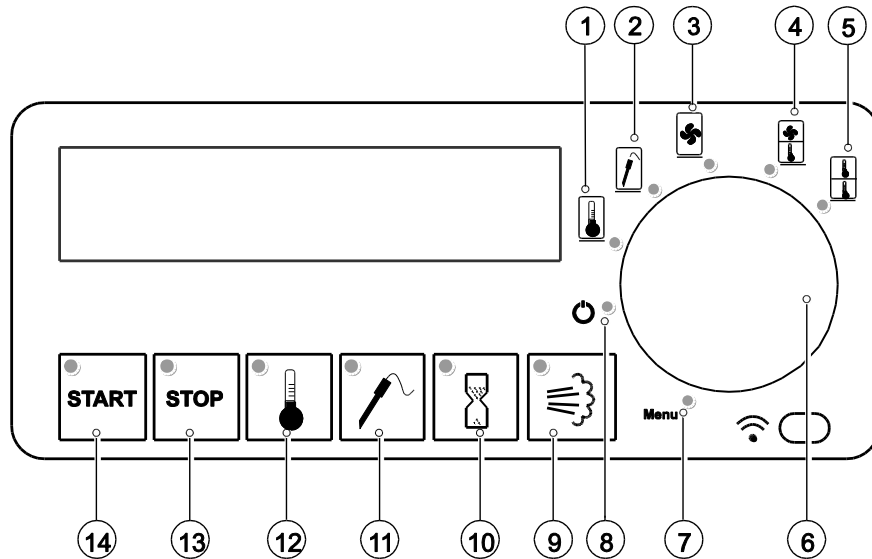

Programs

- | | | | |
|---|--------------------------------|----|--------------------------------------|
| 1 | Cooking at chamber temperature | 6 | Dial,
protrudes when switched off |
| 2 | Cooking at core temperature | 7 | Menu |
| 3 | Fan | 8 | POWER |
| 4 | Hybrid | 13 | STOP |
| 5 | Cooking with 2 chambers | 14 | START |

Adjustment buttons

- 9 Steam / pump out residual water, cleaning / descaling
- 10 Time
- 11 Core temperature
- 12 Chamber temperature

Display

Examples of displays

Meaning



- Appliance is in standby mode.
- The **POWER** LED is flashing.
- Display is black

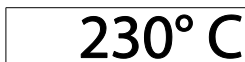

- Program x is running.
- In the lower menu bar, the adjustment buttons flash indicating the most meaningful adjustment options.
- The current chamber temperature is shown in the display.



- F1 in the display indicates: A fault.

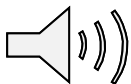

- Acoustic signal: 10 seconds before a task is run automatically, you will hear an acoustic signal, e.g. 10 seconds before the cooking time is over.

7.3.2 Programs

The appliance has the following programs:

- 1 Cooking at chamber temperature
- 2 Cooking at core temperature
- 3 Fan
- 4 Hybrid
- 5 Cooking with 2 chambers

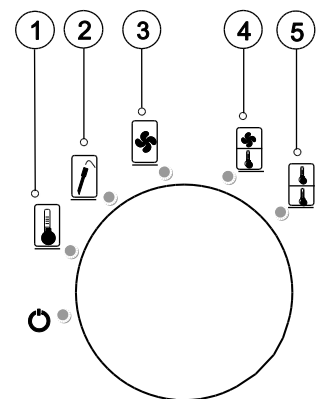

7.3.3 Program settings

Specific settings are available in each program. The appliance has the following setting options:

- 1 Chamber temperature
- 2 Core temperature
- 3 Time
- 4 Humidification with steam

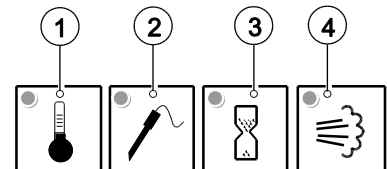

Once you have selected a program, the buttons flash to indicate the most meaningful settings.

The table shows which settings are available in each program:

↓	Program	Chamber temperature [°C]		Core temperature [°C]	Time - duration [h:min]	Steam	Keep warm HOLD	Display during the program	Pump out residual water after use:
	Cooking at Chamber temperature	20 ...	140 ¹ 200 ²	—	1:30	0, Dry, 1, 2	20 ... 140 ¹ / 200 ²	Chamber temperature	
	Cooking at Core temperature	20 ...	140 ¹ 200 ²	20 ... 77	—	0, Dry, 1, 2	20 ... 140 ¹ / 200 ²	Chamber temperature	 > 6 sec.
	Fan When cooling, use cooling pellets, max. 6 hours	—		—	1:30	—	—	Chamber temperature	
	Hybrid Top fan/cool and bottom for cooking	— 20 ...	140 ¹ 200 ²	—	1:30	0, Dry, 1, 2	—	Chamber temperature	
	Cooking with 2 chambers								
	Upper chamber	20 ...	140 ¹ 200 ²	—	1:30	0, Dry, 1, 2	—	Chamber temperature	
	Lower chamber	—		20 ...77	140 ¹ 200 ²	—	—		

¹ hybrid kitchen 140

² hybrid kitchen 200

7.4 Programs

7.4.1 Cooking at chamber temperature

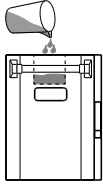

- For cooking with steam, fill the water tank with drinking water beforehand up to a maximum of 1 cm below the top, ca. 0.5 l.
- Put the food into a GN container.
- Place the filled GN container inside the appliance.
- Close the door.

- Select the program **Cooking at chamber temperature** by turning the **dial**.

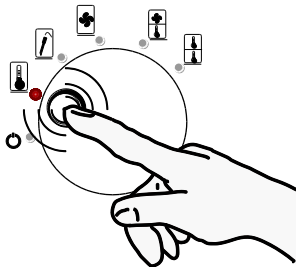

- Press the **dial** to open the program.
 - In the lower menu bar you will see flashing buttons, indicating that you can make finer adjustments to the program.

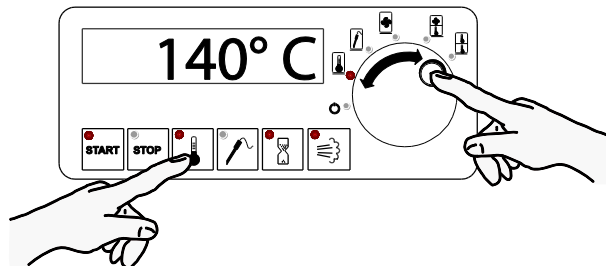

- Set chamber temperature.
 - With the **left hand**, keep the adjustment button for **Chamber temperature** held down.
 - Set the required value at the **dial** by **using the right hand**.

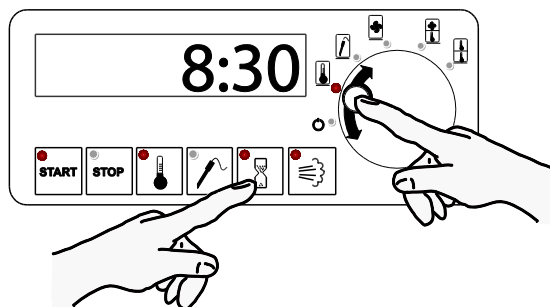

- Set time.
 - With the **left hand**, **keep** the adjustment button for **Time** held down.
 - Set the required value at the **dial** using **the right hand**.

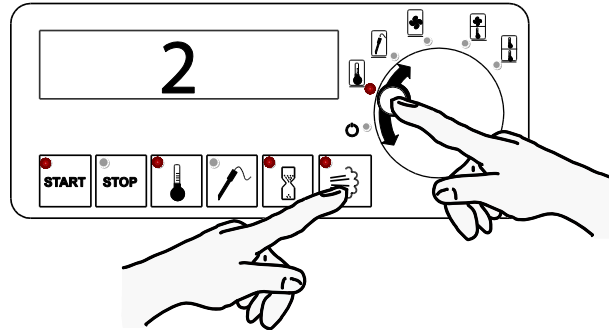

- Set humidification with steam.
With the **left hand**, keep the adjustment button for **Steam** held down.
Set the required value at the **dial** using your **right hand**.

0	No steam
Dry	No steam
1	Steam
2	intense steam

■ When 50°C is reached, the water pump starts with a pre-pumping time of 6 seconds.

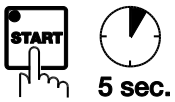

- Keep the **START** button held down for about 5 seconds.
 - The program **Cooking at chamber temperature** now starts.

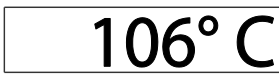

■ The display shows the current chamber temperature.



- A signal sounds after expiry of the cooking time.
- The program continues.

7.4.2 Cooking at core temperature

The core temperature sensor measures the core temperature of the cooking product and regulates the appliance.

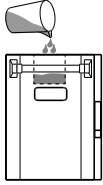

- For cooking with steam, fill the water tank with drinking water beforehand, up to a maximum of 1 cm below the top, ca. 0.5 l.
- Put the product you want to cook into a GN container.
- Place the GN container inside the appliance.
- Close the door.

- Put the core temperature sensor into the product.

- Select the program **Cooking at core temperature** by turning the **dial**.

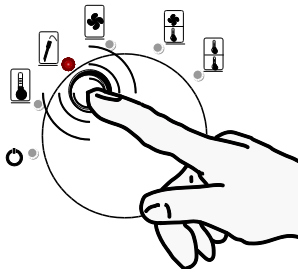

- Press the **dial** to open the program.
 - In the lower menu bar you will see flashing buttons, indicating that you can make finer adjustments to the program.

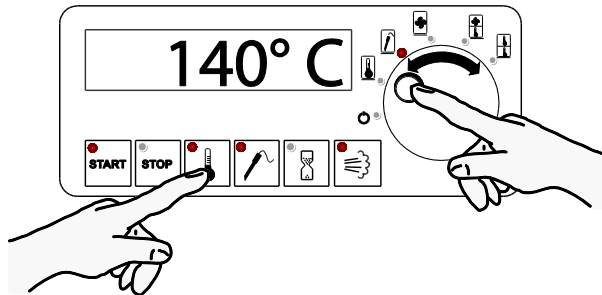

- Set chamber temperature.
 - With the **left hand**, keep the adjustment button for **Chamber temperature** held down.
 - Set the required value at the **dial** using your **right hand**.
 - The control panel applies the set value.

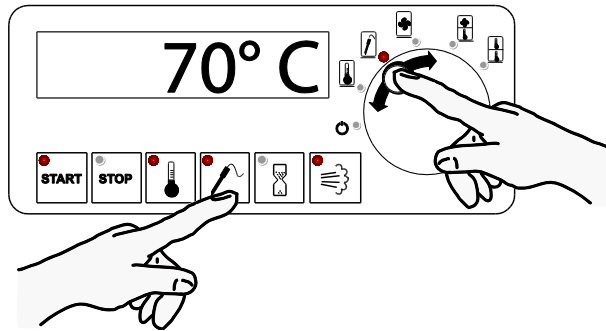

- Setting the core temperature.
With the **left hand**, keep the adjustment button for **Core temperature** held down.
Set the required value at the **dial** using your **right hand**.

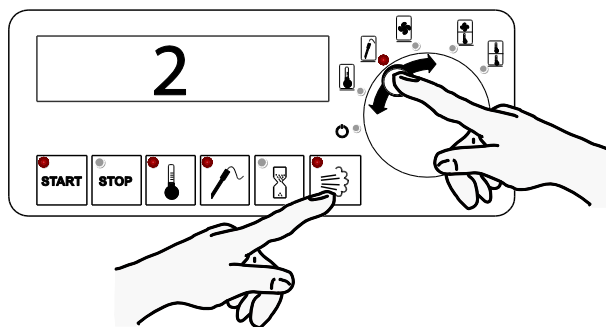

- Set humidification with steam.
With the **left hand**, keep the adjustment button for **Steam** held down.
Set the required value at the **dial** using your **right hand**.

0	No steam
Dry	No steam
1	Steam
2	intense steam
- When 50°C is reached, the water pump starts with a pre-pumping time of 6 seconds. Water can enter the interior during this process.

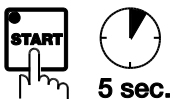

- Keep the **START** button held down for about 5 seconds.
■ The program **Cooking at core temperature** now starts.



- The display shows the current chamber temperature.

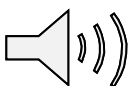

- A signal sounds after expiry of the cooking time.
- The program continues.

7.4.3 Fan

With this program, you can cool food passively if you put cooling pellets into the appliance. Use this program for a maximum of 6 hours.

- Put the food into a GN container.
- Place the GN container inside the appliance.
- Put the cooling pellets into the appliance.
- Close the door.

- Set the **Fan** program by turning the dial.

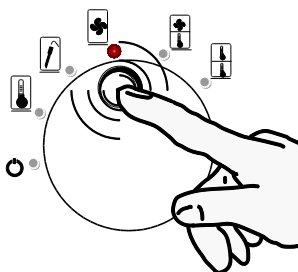

- Press the **dial** to open the program.
 - In the lower menu bar you will see flashing buttons, indicating that you can make finer adjustments to the program.

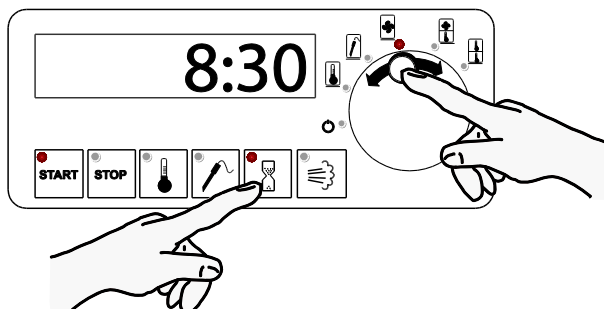

- Set time.
 - With the **left hand**, **keep** the adjustment button for **Time** held down
 - Set the required value at the **dial** using your **right hand**.

- The control panel applies the set value.

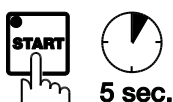

- Keep the **START** button held down for about 5 seconds.
 - The **Fan** program starts.



- The display shows the current chamber temperature.

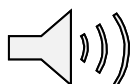

- When the set time is over, an acoustic signal sounds.
- The program continues.

7.4.4 Hybrid - passive cooling and keeping warm

With this program you can do these things at the same time:

- in the upper chamber, cool foods passively with the cooling pellets and circulating air and
- in the lower chamber, keep food warm.

The 2 chambers are separated by an insulated divider.

In the upper chamber, the temperature when cooling can increase by max. 7°C per hour.

Foods can only be steamed in the lower chamber.

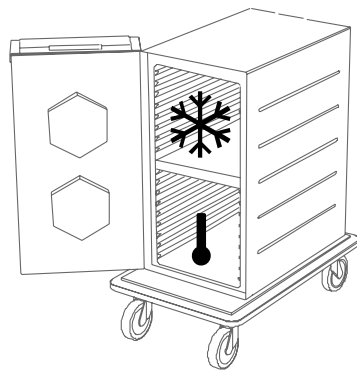

- For cooking with steam humidification, fill the water tank with drinking water beforehand, up to a maximum of 1 cm below the top, ca. 0.5 l.
- Put the food into a GN container.
- Insert the insulated divider.
- Place the cooling pellets in the upper chamber.
- Place the GN container you want to cool in the upper chamber.
- Place the GN container you want to keep warm in the lower chamber.
- Close the door.
- Select the program **Fan and cooking** by turning the **dial**.

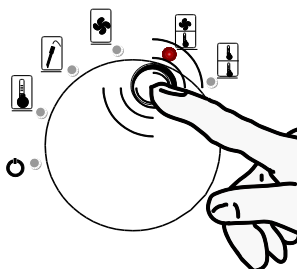

- Press the **dial** to open the program.
■ In the lower menu bar you will see flashing buttons, indicating that you can make finer adjustments to the program.

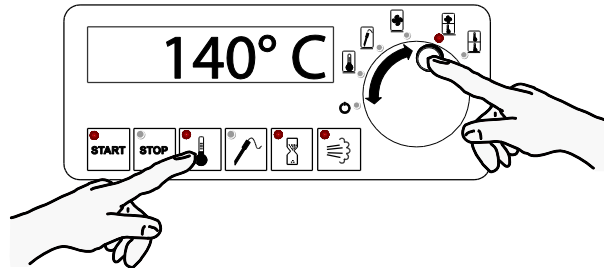

- Set chamber temperature.
With the **left hand**, keep the adjustment button for **Core temperature** held down.
Set the required value at the **dial**, using your **right hand**.

■ The control panel applies the set value.

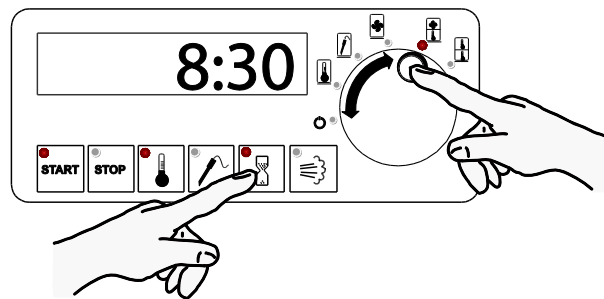

- Set time.
With the **left hand**, keep the adjustment button for **Time** held down.
Set the required value at the **dial**, using your **right hand**.

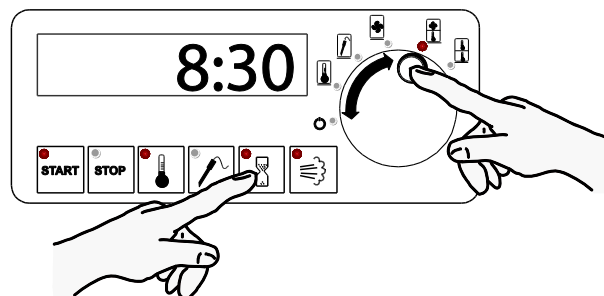

- Set humidification with steam.
With the **left hand**, keep the adjustment button for **Steam** held down.
Set the required value at the **dial**, using your **right hand**.

0	No steam
Dry	No steam
1	Steam
2	intense steam

 - When 50°C is reached, the water pump starts with a pre-pumping time of 6 seconds. Water can enter the interior during this process.

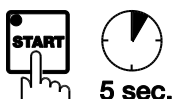

- Keep the **START** button held down for about 5 seconds.
■ The **Fan and cooking** program starts.

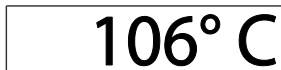

■ The display shows the current temperature in the lower chamber.

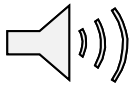

■ A signal sounds after expiry of the cooking time.
■ The program continues.

7.4.5 Cooking with 2 chambers

With this program, you can set two different chamber temperatures.

Steaming is only possible in the lower chamber.

➤ For cooking with steam humidification, fill the water tank **with drinking water beforehand, up to a maximum of 1 cm below the top.**

➤ Put the food into a GN container.

➤ Insert the insulated divider.

➤ Put the filled GN container for cooking at chamber temperature into the top chamber.

➤ Place the other filled GN container for cooking at chamber temperature into the bottom chamber.

➤ Close the door.

➤ Choose the program **Cooking with 2 chambers** by turning the **dial**.

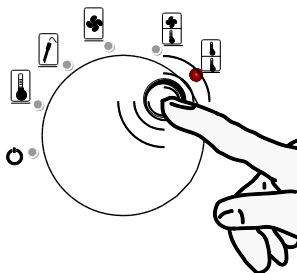

➤ Press the **dial** to open the program.

■ In the lower menu bar you will see flashing buttons, indicating that you can make finer adjustments to the program.

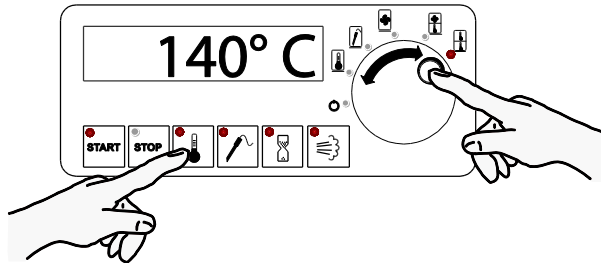

- Set the temperature for the upper chamber.
With the **left hand**, keep the adjustment button for **Chamber temperature** held down.
Set the required value at the **dial** using your **right hand**.

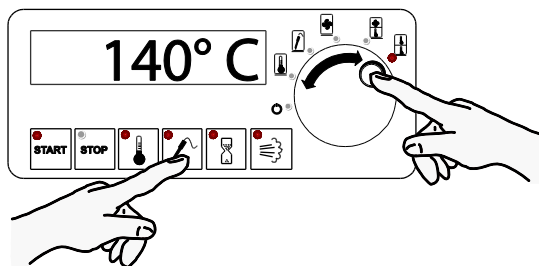

- Set the temperature for the lower chamber.
With the **left hand**, keep the adjustment button for **Core temperature** held down.
Set the required value at the **dial** using your **right hand**.

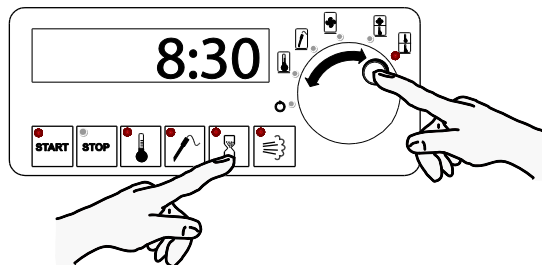

- Set time.
With the **left hand**, keep the adjustment button for **Time** held down.
Set the required value at the **dial** using your **right hand**.

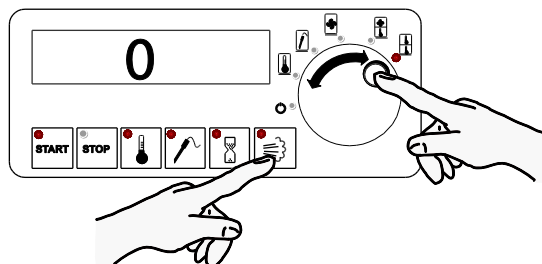

- Set humidification with steam.
With the **left hand**, keep the adjustment button for **Steam** held down.

Set the required value at the **dial** using your **right hand**.

- 0 No steam
- Dry No steam
- 1 Steam
- 2 intense steam

■ When 50°C is reached, the water pump starts with a pre-pumping time of 6 seconds. Water can enter the interior during this process.

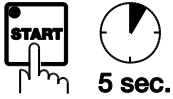

➤ Keep the **START** button held down for about 5 seconds.

■ The program starts.



■ The display shows the current temperature in the lower chamber.

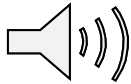

■ A signal sounds after expiry of the cooking time.

■ The program continues.

7.5 Keeping food warm (HOLD)

Using the chamber temperature and core temperature settings, you can follow the cooking process with a keep-warm phase.

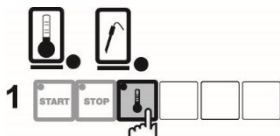

➤ Press and hold down the **Chamber temperature** button.

With your second finger, press and hold down the **STOP** button. Make sure that you do not inadvertently press the **START** and **STOP** buttons at the same time, as in this case the set values will be lost (RESET).

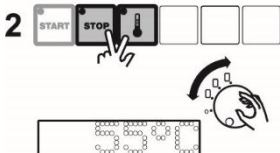

➤ Set the required keep-warm temperature with the **dial**.



➤ Then release the **STOP** button first followed by the **Chamber temperature** button.

■ The keep-warm temperature is saved.

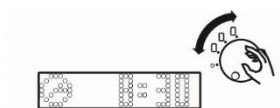

➤ Press and hold down the **Time** button. With your second finger, press and hold down the **STOP** button.

➤ Set the required keep-warm time with the **dial**.

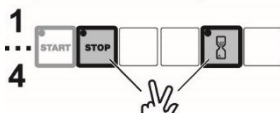

➤ Then release the **STOP** button first followed by the **Time** button.

■ The keep-warm time is saved.

7.6 Display values

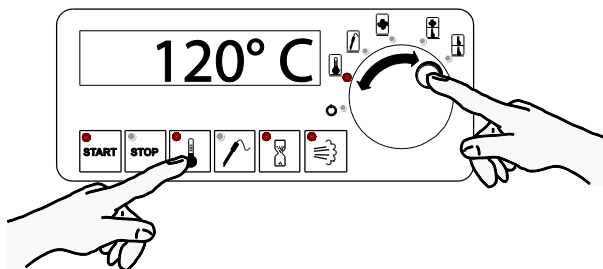

- Press the respective adjustment button briefly.
 - The set value is shown, e.g. the chamber temperature.
 - After about 10 seconds, the current chamber temperature is shown again in the display.

7.6.1 Chamber temperature

- Press the adjustment button **Chamber temperature** briefly.
 - The set chamber temperature is displayed.
 - After about 10 seconds, the display shows the current chamber temperature again.

7.6.2 Core temperature

- Press the adjustment button **Core temperature** briefly.
 - The set core temperature is displayed.
 - After about 10 seconds, the display shows the current chamber temperature again.

7.6.3 Time

Display set time

- Press the adjustment button **Time**.
 - The set time is displayed.
 - After about 10 seconds, the display shows the current chamber temperature again.

Display remaining time

- Press the **Time** adjustment button and then release.
 - The remaining time is displayed.
 - After about 10 seconds, the display shows the current chamber temperature again.

7.6.4 Humidification with steam

- Press the **Steam** adjustment button briefly.

■ The set value is displayed.

0	No steam
Dry	No steam
1	Steam
2	intense steam

■ After about 10 seconds, the display shows the current chamber temperature again.

7.7 Change during operation

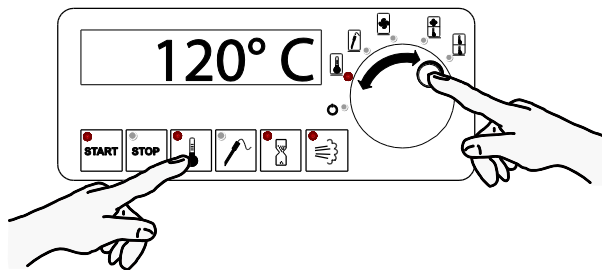

- With the **left hand**, keep the respective **adjustment button** held down.
- Set the required value at the **dial**, using your **right hand**.
 - The control panel applies the set value for the current cooking process.

7.8 Reset program (RESET)

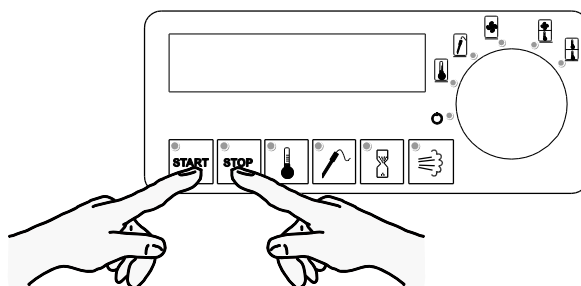

- Press the **START** button and the **STOP** button at the same time for about **10 seconds**.
 - The control panel resets the program settings.

7.9 Cancel program / Standby mode

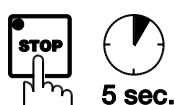

- Keep the **STOP** button held down for about 5 seconds.
- The currently running program is cancelled.

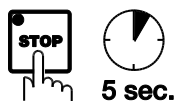

- Keep the **STOP** button held down for about 5 seconds.
- The appliance switches to **Standby** mode.
- The **POWER** LED lights up.

Cancel menu with start time

 See "Unlock menu with start time", page 44

7.10 Program end



- A signal sounds after expiry of the cooking time.
- The program continues.

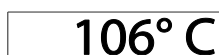

- The display shows the current chamber temperature.

7.11 Switch appliance off

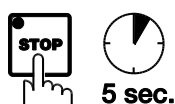

- Keep the **STOP** button held down for about 5 seconds.
- The currently running program is cancelled.

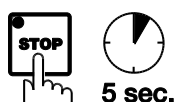

- Keep the **STOP** button held down for about 5 seconds.
- The appliance switches to Standby mode.
- The **POWER** LED lights up.
- The display shows the current chamber temperature.

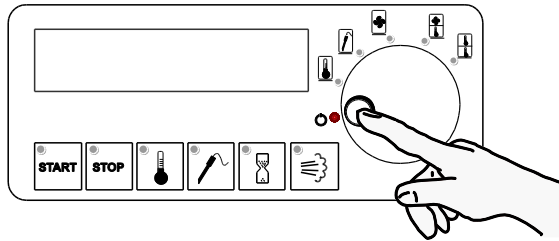

- Turn the **dial** to the **POWER** setting.
 - The readings in the display disappear.

7.12 Set date and time

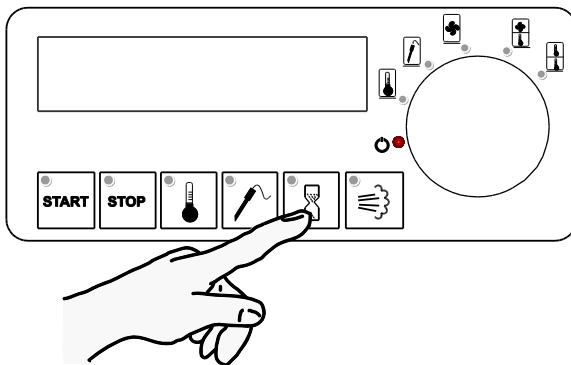

- In standby mode, keep the **Time** Button held down for about 5 seconds.

- Use the **dial** to set the required date.
- Press the **dial**.
 - The new value is saved.



- Use the **dial** to set the required time.
- Press the **dial** again.
 - The new value is saved.
- To close the setting, press the **STOP** button.
 - The device is in standby mode.

7.13 Call up and save menu

You can set, save and open programs again later.

Once programmed, it is easy for briefed operating personnel to prepare food.

A saved menu is either

- accessible again immediately and can be changed while running (= **Menu without start time**)
or
- has its own start time and cannot be changed while running (= **Menu with start time**).

7.13.1 Open menu

Open menu without start time

- For cooking with steam, fill the water tank with **drinking water** beforehand to a maximum of 1 cm below the top edge.

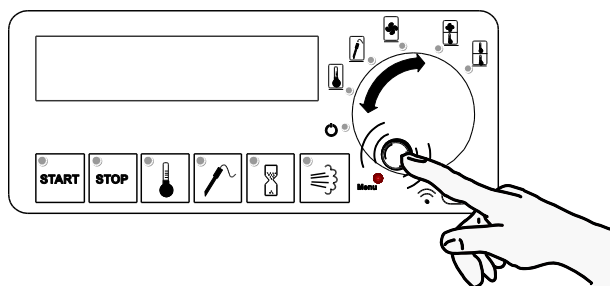

- Turn the dial to the **Menu** setting.
- Press the dial.
| Menu no. 1 is shown in the display.

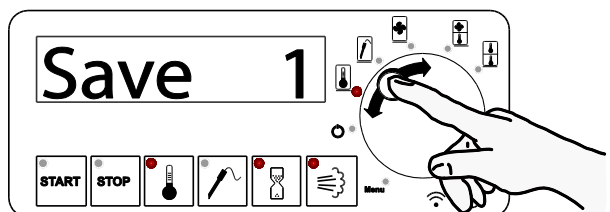

- By turning the dial you can select the menu number you want.
You can see which program is for the displayed menu by the LED on the dial.
The LED flashes when the menu place is available.
Assigned menu places are lit.
Menus with start time are identified by a **T** in the display.
- Press the dial to confirm the menu you want.

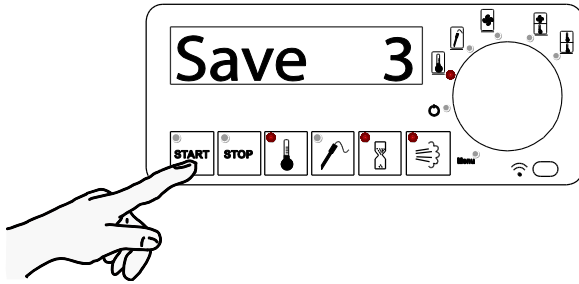

- Press the **START** key.
- The selected menu starts.

- The display shows the current chamber temperature.

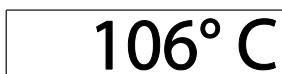

Changing a value while the program is running

If you change a value while the program is running, this will only affect the current procedure. The menu is not overwritten.

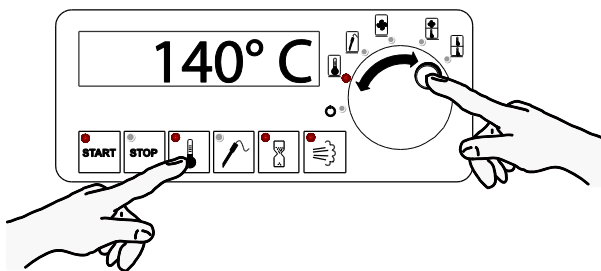

- Keep the respective **adjustment button** held down.
- At the **dial** set the value you want and then release it to activate the set value.
- The changed setting is only applied to the current cooking process.

Open menu with start time

- For cooking with steam humidification, fill the water tank **beforehand, up to a maximum of 1 cm below the top.**

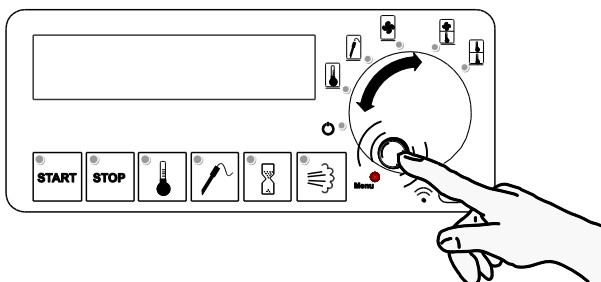

- Turn the **dial** to the **Menu** setting.

- Press the dial.

■ Menu no. 1 is shown in the display.

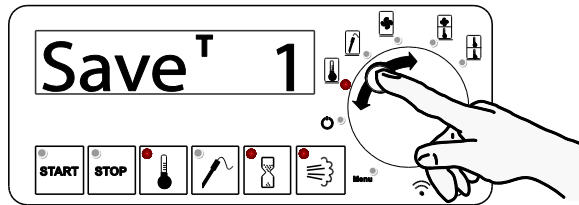

- By turning the **dial** you can select the menu number you want. You can see which program is for the displayed menu by the LED on the dial. Menus with a start time are identified by a T in the display.
- Press the **dial**.

■ First, the following picture is shown in the display:

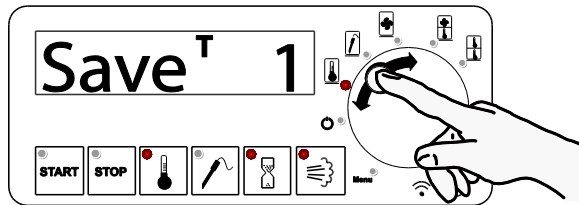

■ Then the display shows the start time.

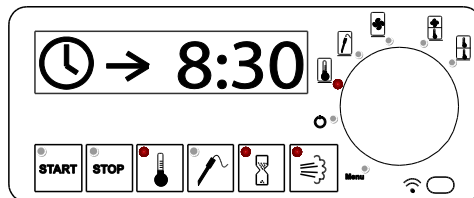

■ The menu starts at the set time.

■ The chamber temperature is shown in the display.

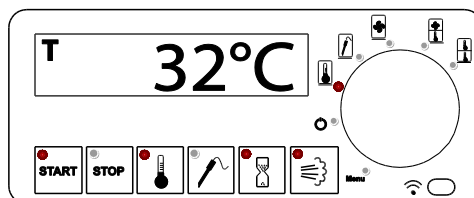

Cancel menu with start time

 See "Unlock menu with start time", page 44

7.13.2 Save menu

- Set required values for the program.

 See chapter "Select program", page 23

- Press the **dial** for about 5 seconds.

| The following picture is shown in the display:

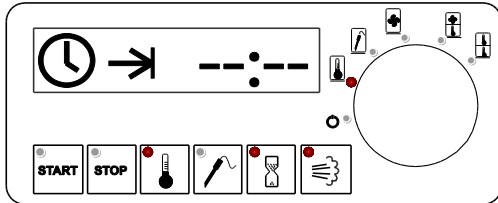

A saved menu is either

1. accessible immediately or can be changed while running (= **Menu without start time**) or
2. has its own start time and cannot be changed while running (= **Menu with start time**).

Save menu without start time

- Keep the **dial** held down.

| The next available menu number flashes in the display. Previously assigned menu-numbers are lit up.

| Use the **dial** to select the menu number you want.

- Press the **dial** to save the entered settings under the specific menu number x or to overwrite. You can save 31 different menus.

| The display shows an **OK!**

Save menu with start time

- Use the **dial** and the **adjustment buttons** to select the required settings.

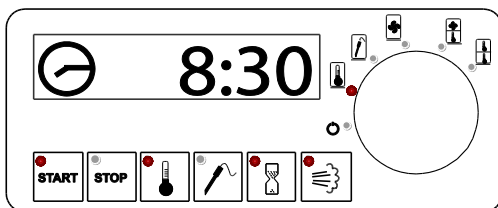

- Keep the **dial** held down.
 - The display shows a clock, a flashing arrow and symbolically shows the time as --:--.
 - Use the **dial** to set the required start time.
- Press the **dial**.
 - The next free menu number flashes. Assigned menu numbers are lit up.
- Press the **dial** to save or overwrite the entered settings under the required menu number. 31 different menus can be saved.
 - The display shows: **'Saving please wait'**.

- After saving the set start time of the program is shown in the display.

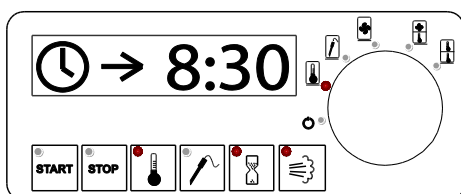

- The program starts automatically at the set time.
- During an automatically run program, the current chamber temperature is shown.

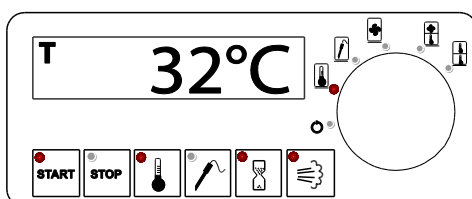

- While it is running, the set values cannot be changed.

- When the program has finished, the display shows **"Ready"** in the display for about one hour.

There are 2 subsequent options:

- Press the **dial**.
 - The menu for the next day is opened again.
- Or
- The setting can be unlocked.

 See "Unlock menu with start time", page 44.

7.13.3 Unlock menu with start time

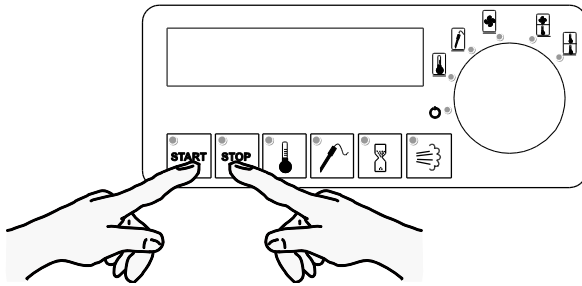

- Press the **START** and the **STOP** buttons at the same time.
 - The display shows 0000.
- Use the **dial** to set the preset start time as a value, e.g. start time 14:30 - value 1430.
- Press the **dial**.
 - The current chamber temperature is shown in the display.

7.13.4 Preinstalled menus

- For menus with steam humidification, fill the water tank **with drinking water beforehand, up to a maximum of 1 cm below the top.**

Menu	Function	Chamber temperature	Time [min]	Steam	Core temperature	Comments
1	Regeneration	140 °C	1:30	2		Cook & Chill
2	Regeneration	140 °C	0:15	1		Hotel industry
3	Cook	120 °C	0:20	2		Rice
4	Cook	140 °C	1:15	0		Pork
5	Core temperature	130 °C		0	58 °C	Roast beef
6	Core temperature	130 °C		0	50 °C	Turkey breast
7	Hybrid	80 upper passive, lower				Warm/cold issue
8	2 chambers	80 upper 140 °C lower	1:30	1		Keep warm Regeneration
9	2 chambers	120 upper passive, lower				Cook Keep warm
10	Circulating air	passive				Pellets

8 Cleaning, maintenance and care

This chapter will help you to meet the hygiene requirements. Before reading this section, please read through the "General safety instructions" section thoroughly first.

8.1 Safety information relating to cleaning, maintenance and care

Risk of burns and scalds to hands, arms and face

The temperature inside the appliance can be up to +200 °C.



WARNING

Risk of burns and scalds to hands, arms and face.



- ▶ When the door lock is first pulled, the door opens by around 1 cm. Allow the appliance to cool down before cleaning.
- ▶ Wear protective gloves.

Avoid risks from electricity



WARNING

Danger of electric shock. Risk of death.

- ▶ Disconnect the appliance from the mains; disconnect the power supply unit.
- ▶ Protect the appliance against moisture. Never direct a jet of water at electrical components such as heater, controller or ventilation grille.
- ▶ Check the heating and connecting cable for any damage.
- ▶ Do not use a steam cleaning unit to clean electrical appliances. Doing so may allow moisture to get into the electrical system and cause a short circuit. Do not expose to spray water. Wipe electrical parts with a moist cloth only and dry the surface using a dry cloth.
- ▶ Have electrical equipment inspected ³ by a **Qualified electrician** in accordance with DGUV. Define the inspection cycle according to the conditions of use. Generally this is every 6 months.

Risk of stab wounds when handling the pointed core temperature sensor



WARNING

Risk of stab wounds when handling the pointed core temperature sensor.

- ▶ Be careful.
- ▶ Keep the core temperature sensor in the holder on the inside of the door when not in use.

³ Source: DGUV Regulation 3. Electrical Systems and Equipment



CAUTION

When inserting the core temperature sensor into the ventilation grille of the circulating air heater, the heater could be damaged; substantial damage to the appliance is possible.

- ▶ Keep the core temperature sensor in the holder on the inside of the door.

8.2 Cleaning agents for stainless steel

The following applies for all cleaning agents:

- Observe the instructions for use provided by the cleaning agent manufacturer.

Mechanical cleaners for stainless steel

Cleaning agent	Suitable
Brush products	Brushes with natural or synthetic bristles
Textiles	Textile material comprising natural and chemical cleaning fibres and textile fabrics (knitted and woven fabric, cleaning cloths, floor cloth, fringed material, fleece). Microfibre cleaning textiles are ideal for removing finger marks from stainless steel surfaces.
Synthetic fleece	Without abrasives. Mainly produced in the colours white, beige, yellow.
Other	Natural leather (chamois), synthetic leather, synthetic fleece, sponges, sponge cloths

Chemical cleaners for stainless steel

Cleaning agent	Areas of application
All-purpose cleaners	Particularly for lighter grease stains.
Neutral cleaners	For surfaces soiled with grease and oil (fingerprints); also suitable as a dishwashing detergent.
Alcohol cleaners	As all-purpose cleaner
Alkaline cleaners	Especially for heavy grease and oil stains (dried-in oils). Observe the manufacturer's dosage instructions.
Solvent cleaners	Depending on the type, particularly good for the removal of grease, oil, wax, tar, adhesives, paints and lacquers. Not suitable for plastics.
Disinfectant cleaners	Effect on pathogenic germs differs depending on active disinfectant ingredient. Long-term exposure to sodium hypochlorite can cause damage to the material. It should not be used if possible. Products should be used, which are specified in the list of the German Society of Hygiene and Microbiology (DHGM).

8.3 Choose the correct cleaning method



CAUTION

Incorrect cleaning can damage the surface or even destroy the appliance. Please note:

- ▶ Do not scratch the surface with sharp-edged objects. Do not use any abrasive or aggressive cleaning agents, such as oven spray or a sponge with an abrasive surface.
- ▶ Remove dirt with cleaning and care products that are suitable for stainless steel.
- ▶ Do not mix standard cleaning agents; do not produce your own cleaning agent.
- ▶ Do not use steel wool or steel brushes.
- ▶ Avoid extended exposure of stainless steel to liquid containing salt, as this can lead to surface discolouration and corrosion.
- ▶ Avoid direct, extended contact of stainless steel with corroding iron parts, e.g. cast iron pans or steel kitchen sponges.

Clean and service stainless steel parts

→ Applies to the housing



CAUTION

Incorrect cleaning can cause damage to the surface.

- ▶ Clean the appliance with a **mild washing up detergent diluted in hot water**, wiping it with a **damp, scratch-free cloth**. After cleaning, rub surfaces dry with a **soft cloth**.



User tip

- ▶ We recommend **Rieber cleaning agent for stainless steel** for cleaning stainless steel.

It is an especially thorough yet gentle cleaner, produces a dazzling shine, and cleans and protects in one.

Order no.: 72 10 24 08

Clean and service plastic parts

→ Applies to the operating and display elements and the door seal













CAUTION

Incorrect cleaning can cause damage to the surface.

- ▶ Clean the appliance with a **mild washing up detergent diluted in hot water**, wiping it with a **damp, scratch-free cloth**. After cleaning, rub surfaces dry with a **soft cloth**.

8.4 Overview of cleaning and maintenance intervals

Interval	Activity to be performed	Page
Daily after use	Pump out residual water, rinse appliance	 Page 48
	⚠ WARNING Turn the unit off. Unplug the mains plug.	
	Remove door if necessary	 Page 50 et seqq.
	Clean door	 Page 50 et seqq.
	Clean core temperature sensor	 Page 50 et seqq.
	Clean interior, clean outside of housing	 Page 47, 50 et seqq.
If required	Clean seals	 Page 50 et seqq.
	Clean castors	 Page 50 et seqq.
Every 180 working days or 6 months	Descalc appliance, at least once every 3 months	 Page 52
	Have electrical system /control checked in accordance with DGUV	 Page 45
	Ensure preservation of the product identification	 Page 13

8.5 Pump residual water out of the appliance, rinse the appliance

Pump out residual water

Pump all residual water out of the appliance daily after use. If residual water remains in the appliance, this can impair the taste of the food.

- Place an empty GN container on the lowest support rail in the appliance.

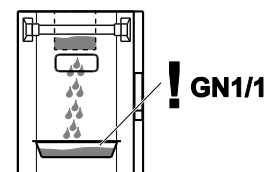
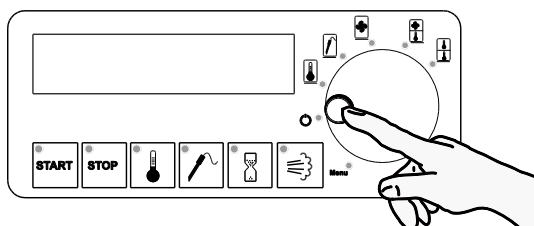

- Turn the **dial** to the **POWER** setting.
█ The corresponding LED lights up.

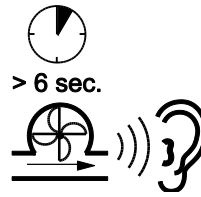
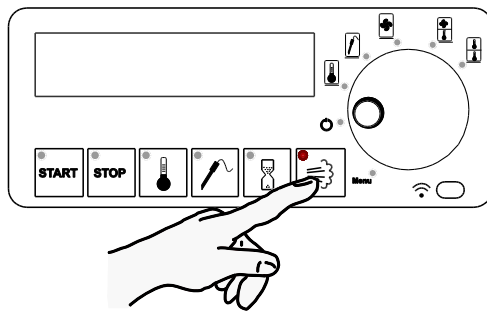

- Press the **Humidification button** continuously, until you hear the water pump switch on. The pumping out process lasts around 5 or 6 seconds. Do not interrupt the process, otherwise the pumping out process will begin again at the next START.
- Check that the water has been completely pumped out of the water tank and the interior. Repeat the process if necessary.
- Empty the GN container.

Rinse the appliance

- Place an empty GN container on the lowest support rail in the appliance.
- Pour **around 0.5 litres of drinking water** into the water container.

Note: The water pump requires three pumping out processes for the 0.5 litres of water.

- Press the **Humidification button** continuously, until you hear the water pump switch on.
- When the water pump switches off again, press the **Humidification button** again continuously, until you hear the water pump switch on. Repeat the process again, to pump out the water completely.
- Empty the GN container.

- Clean the water container and lid.
- Clean the opening in the rubber plug, if necessary use a thin wire to clear it.

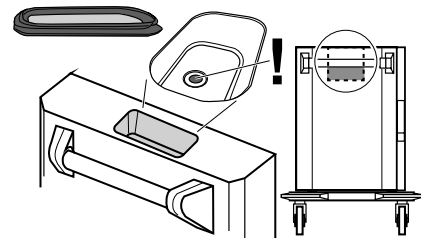

- **i** User tip. We recommend descaling the appliance regularly, at least **once a month** for intensive use, at least **once every 3 months**, depending on use.



See 'Descal the appliance as required', page 52

8.6 Cleaning

Prerequisite

- The residual water has been pumped out of the appliance, the appliance has been rinsed.



See 'Pump residual water out of the appliance, rinse the appliance', page 48

➤ WARNING

Before cleaning the device, switch it off and disconnect from the mains.

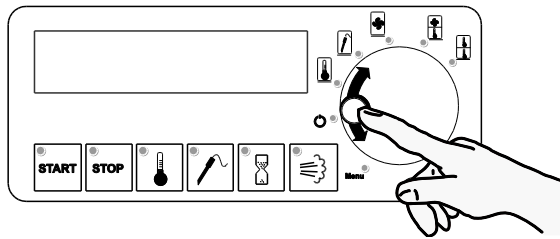

- Turn the dial to the **POWER** setting.
 - If necessary, press the **dial** again to switch off the appliance.
 - The respective display is no longer lit.
-

- Open door and allow hot appliance to cool down.

Clean door

➤ WARNING

Clean the door to the operating unit, the heating elements and fans with a **slightly damp cloth**. After cleaning, rub surfaces dry with a **soft cloth**.

Remove door if necessary

- Take hold of the door with both hands at the handle, and lift it out and upwards.
- **CAUTION**
Place the door carefully on a soft surface.

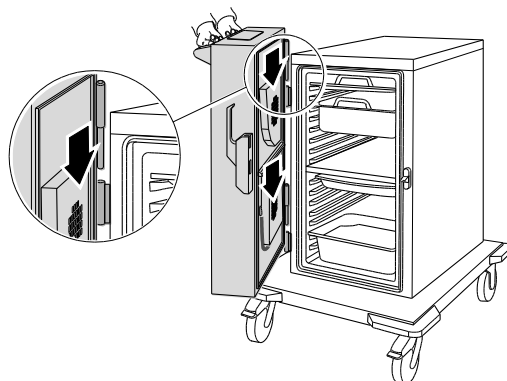

Clean core temperature sensor

- **⚠ WARNING**
Risk of **stab wounds** when handling the **pointed core temperature sensor**.
Be careful.
- Clean the core temperature sensor with a **damp cloth**.
- **CAUTION**
Keep the core temperature sensor in the **holder** on the inside of the door.

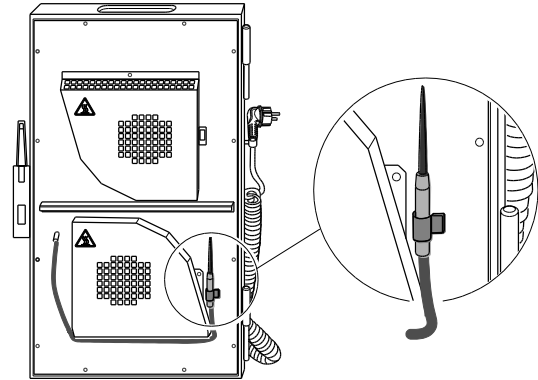

Clean housing interior and exterior

- Clean the interior and exterior of the housing with a **slightly damp cloth**. After cleaning, rub surfaces dry with a **soft cloth**.

Clean seals

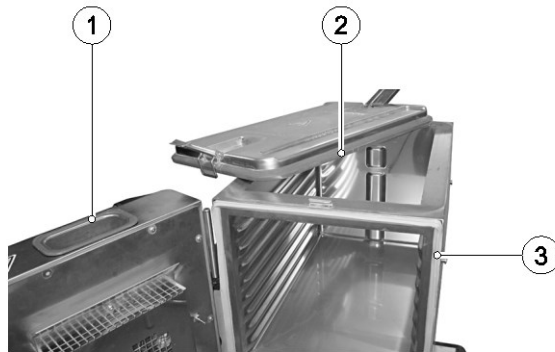

- 1 Seal on the lid of the water container
- 2 Seal
- 3 Door seal

- **CAUTION**
Seals may not be cleaned with oven spray. The spray can destroy the seal.
- Clean seals at least once a week.

- **i** User tip. Clean the door seal in the dishwasher.

- **Mild** washing up detergent diluted in hot water is ideal for cleaning. After cleaning, rub surfaces dry with a **soft cloth**.

Clean castors if necessary



CAUTION

Cleaning the castors incorrectly can damage them.

- ▶ Clean the castors with a **mild washing up detergent diluted in hot water**, wiping it with a **damp, scratch-free cloth**. After cleaning, rub surfaces dry with a **soft cloth**.

8.7 Descal the appliance as required



User tip

Signs of calcification are visible limescale and extended processing time, increased noise generation, intense steam generation.

- ▶ Descal the appliance before a thorough cleaning; at least **once a month** for intensive use, at least **once every 3 months** depending on use.

▶  **WARNING**

Use a commercially available descaler for domestic appliances. Observe the manufacturer's instructions.

- ▶ Prepare the **descaling solution** with **0.5 litres** of drinking water and the quantity of descaler specified by the manufacturer. Pour these in.

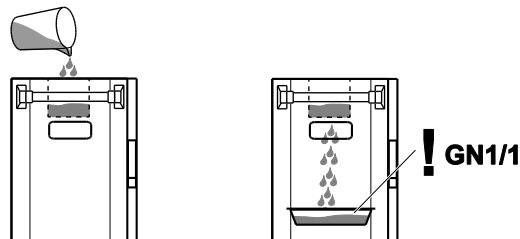

- ▶ Place an empty GN container on the lowest support rail in the appliance.

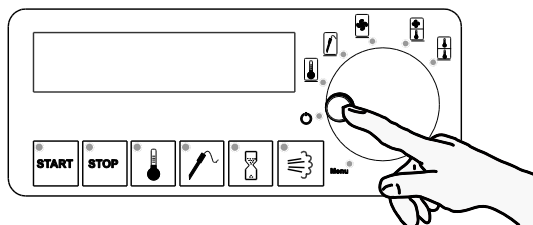

- ▶ Turn the **dial** to the **POWER** setting.
■ The corresponding LED lights up.

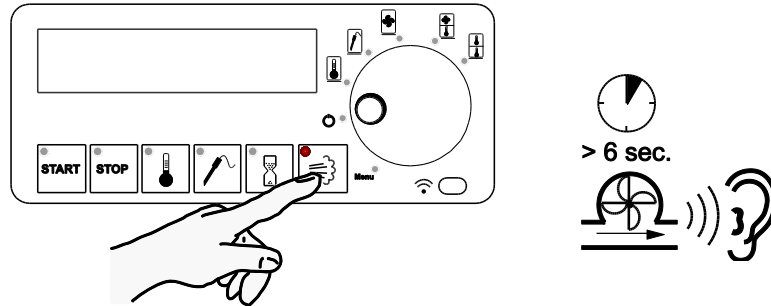

- Press the **Humidification button** continuously, until you hear the water pump switch on.
- Wait until the water pump switches off again and leave the descaling solution to work in accordance with the manufacturer's instructions, around 10 minutes.
- Then press the **Humidification button** continuously, until you hear the water pump switch on and the descaling liquid is pumped out.
- When the water pump switches off again, press the **Humidification button** again continuously, until you hear the water pump switch on and the remaining descaling solution is pumped out. Wait until the descaling solution is completely pumped out.
- Empty the GN container.

Rinse the appliance 3x.

- Place the empty GN container on the lowest support rail in the appliance.
- Pour **around 0.5 litres of drinking water** into the water container.

Note: The water pump requires three pumping out processes for the 0.5 litres of water.

- Press the **Humidification button** continuously, until you hear the water pump switch on.
- When the water pump switches off again, press the **Humidification button** again continuously, until you hear the water pump switch on. Repeat the process again, to pump out the water completely.
- Empty the GN container.
- Repeat the complete rinsing process twice more.
- Check that the water has been completely pumped out of the water tank and the interior. Repeat the process if necessary.



See 'Pump residual water out of the appliance, rinse the appliance'; Page 48

8.8 Keep ready for next use in dry condition

- Dry the inside of the appliance and leave the door open until the residual moisture has dried off.
- Store appliance at room temperature.

9 Troubleshooting



WARNING

Danger of electric shock. Dangerous electrical voltage.

- ▶ Disconnect appliance from mains before any repair work.
- ▶ Have all electrical repairs carried out by an authorised electrician only.

Any repairs during warranty period may only be carried out by the Rieber service department. Please contact the Rieber service department.

The housing of the circulating air heater may only be opened/closed for the purpose of thorough cleaning by appropriately trained and authorised operating personnel (qualified electrician). This is only permitted by the manufacturer's service department during the guarantee and warranty period.

If there is a fault, **F1** is shown in the display.

Fault	Possible cause	Possible remedy
F1 in the display	Malfunction	<ul style="list-style-type: none"> ➤ Call Rieber Service or contractual partner # Operating staff
Appliance does not heat up	Heating defective Sensor defective Controller defective	<ul style="list-style-type: none"> ➤ Repair # Rieber Service or authorized partner
Operating panel Not functioning	Operating panel defective	<ul style="list-style-type: none"> ➤ Repair # Rieber Service or authorized partner
Steam not functioning	No water in the water container Scale or dirty	<ul style="list-style-type: none"> ➤ Pour drinking water into the water container # Operating staff ➤ Descale, clean # Operating staff
Castor defective	Wear, damage	<ul style="list-style-type: none"> ➤ Replace # Specialist for mechanic's work
Residual water is not pumped out	Water pump defective	<ul style="list-style-type: none"> ➤ Repair # Rieber Service or authorized partner

Customer service, spare parts



IMPORTANT

Customer service needs information about the type and number of your appliance.

- If you have a fault you cannot remedy yourself, please get in touch with your Rieber partner or Rieber central customer service.

Disposing of your product



Your device is made of high-quality materials that can be re-used or recycled. For disposal, disconnect the appliance from mains supply. Unplug the mains plug. Cut off the plug at the casing. Dispose of this appliance properly via your local disposal facility.



WARNING

Persons with limited sensory and mental ability might get locked in.

- ▶ When disposing of the unit, destroy the door lock.
-

10 Index

Acoustic signal	23	Overview of intervals.....	48
Adjustment buttons	22	POWER	22
Cancel program.....	37	Program settings.....	23
Chamber temperature	24	Programs	22, 23, 24
Chamber temperature button	22	Cooking at Chamber temperature	24
Change settings	36	Cooking at Core temperature	24
Cleaning.....	50	Cooking at chamber temperature.....	25
Doorseal.....	51	Cooking with 2 chambers.....	32
Cooking at Chamber temperature	24	Fan.....	24, 29
Cooking at chamber temperature.....	22, 25	Fan and cooking.....	30
Cooking at core temperature.....	22	Pump residual water	48, 50, 53
Cooking at Core temperature	24	Remaining time	35
Cooking with 2 chambers.....	22, 32	Reset program	36
Core temperature	24	Residual current device.....	9
Core temperature button	22	Safety cut-out.....	9
Descal	52	Save menu.....	42
Dial.....	22	Save menu with start time.....	42
Display	23	Save menu without start time.....	42
Display values.....	35	Seal.....	51
Chamber temperature	35	Set date.....	38
Time	35	Set time.....	35, 38
Disposing	55	Signal sound	37
Door lock.....	9	START button	22
Fan.....	22, 24, 29	Steam.....	24
Fan and cooking.....	22, 30	Steam button.....	22
HOLD	34	STOP button	22
Keeping food warm	34	Switch off	37
Menu	22, 39	Time - duration.....	24
Preinstalled	44	Time button	22
Open menu	39	Troubleshooting	54
Open menu with start time	40	Unlock menu with start time	44
Open menu without start time	39	Warranty and liability.....	57
Operating panel.....	22	Water tank.....	20

11 Warranty and liability

Manufacturer liability and warranty shall no longer apply if

- you do not follow the information and instructions in this user guide,
- do not use the device as it is intended,



See chapter "Designated purpose of use"

- make conversions or functional modifications,
- do not use original spare parts.

The "Sales and delivery terms and conditions" of Rieber GmbH & Co. KG shall apply for all warranty claims made against the manufacturer. For instance, any repairs and/or overhaul during the warranty period may only be performed by the manufacturer's service department of Rieber, failing which any claims hereof may be voided. Please contact the manufacturer's service department at Rieber.

The following wear parts are not included in the warranty:

- Caster, caster with parking brake, corner guard

12 Excerpt from the EU Declaration of Conformity

EC Declaration of Conformity according to EC Machinery Directive 2006/42/EC

Rieber GmbH & Co. KG hereby declares that the product

- **hybrid kitchen 140**
- **hybrid kitchen 200**

comply with the basic requirements of the EC Machinery Directive 2006/42/EC, Appendix II A, harmonised standards (DIN EN ISO 12100: Safety of Machinery — General principles for design — Risk assessment and risk minimisation).

EU Declaration of Conformity

in accordance with the European Directive on Electromagnetic Compatibility 2014/30/EU.

Rieber GmbH & Co. KG hereby declares that the product

- **hybrid kitchen 140**
- **hybrid kitchen 200**











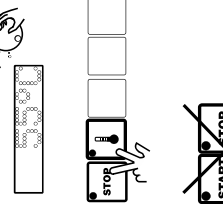

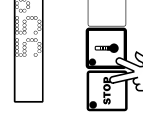









comply with the basic requirements of the European Directive on Electromagnetic Compatibility 2014/30/EU in respect of their electrical design.

If required, a copy of the EC Declaration of Conformity can be obtained from our sales team.

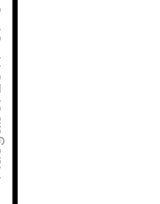
13 Contact address

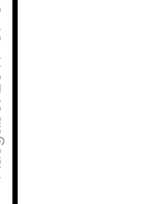
Rieber GmbH & Co. KG
Hoffmannstraße 44
D 72770 Reutlingen, Germany
Phone +49 (0) 7121 518-0
FAX +49 (0) 7121 518-302
Email info@rieber.de
www.rieber.de

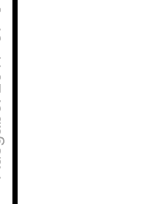
14 Brief instructions

hybrid kitchen 140, hybrid kitchen 200					
START  	1  SETTINGS  	2  	3  	4  	5  
RESET  	optional: HOLD  6 	START PROGRAM  	EXIT PROGRAM  	STANDBY  	
					
Scan for more information.					
Ausgabel: 2017-07-04					