



thermoport[®] Food Transport Containers



The illustrations show configuration examples, which do not necessarily have to be included in the scope of delivery.



Observe the Operating Instructions
Original Operating Instructions

DOWNLOAD: USER MANUAL

QR code on type plate



EN

Rieber Professional. Our solutions guarantee high quality, safety and, above all, excellent energy efficiency and cost effectiveness.

CHECK HACCP – For managing HACCP documentation, the CHECK CLOUD platform offers the CHECK HACCP digital system, for simple, safe and transparent temperature detection.

Additional digital features are also possible in the area of hygiene and service management. The automated digital answer to the analogue paper trail.



Contents

1	Revision Index	4
2	Important Information	4
2.1	The components of the technical documentation	4
2.2	Using this guide	5
2.3	Representation conventions in the text	6
2.4	Structure of safety instructions	6
2.5	Tips on selecting the TP for your specific requirements	7
3	Safety Instructions	8
3.1	General behaviour	8
3.2	On use of electrical appliances	8
3.3	Operator's obligations	9
3.4	Personnel qualification requirements	10
3.5	Provision of personal protective equipment (PPE) for personnel	10
3.6	Appliance-specific safety instructions	11
3.6.1	Risks in transit.....	11
3.6.2	Risks due to electricity	13
3.6.3	Risk of burning and scalding	13
3.6.4	Risks due to refrigerant	14
3.6.5	Risk of suffocation.....	14
3.6.6	Warnings concerning the use of the appliance by children	14
3.6.7	Safety and monitoring devices	14
3.6.8	Please observe the product identification, make sure it is safely maintained.....	15
3.7	Information about regulations to be followed.....	16
3.8	Instructions on behaviour in an emergency.....	16
4	Designated Use	17
5	Description of the Appliance	19
5.1	Designation.....	19
5.2	Technical data	20
5.2.1	General data	20
5.2.2	TP 3000 U heated and TP 3000, (stainless steel)	26
5.2.3	TP 2000 U heated and TP 2000, (stainless steel)	27
5.2.4	TP 3000 hybrid warm/cold active and warm/cold passive, (stainless steel).....	28
5.2.5	TP 1600 DU heated and TP 1600 U heated, and TP 1600, (stainless steel)	29
5.2.6	TP 1400 U heated and TP 1400, (stainless steel)	30
5.2.7	TP 1000 DU, TP 1000 H and TP 1000 N, (stainless steel)	31
5.2.8	TP 105 L, (stainless steel).....	32
5.2.9	TP actively cooled, (mobile, made of stainless steel)	33
5.2.10	TP6000 Maxi for banquet solutions, (mobile, made of plastic)	35

5.2.11	TP 6000 KB heated and TP 6000 K, (plastic)	37
5.2.12	TP 4.0 1000 KB circulating air and TP 1000 K, (plastic)	38
5.2.13	TP 600 KB and TP 600 K, (plastic)	39
5.2.14	TP 100 K hybrid, TP 100 KB heated, TP 100 K, TP 100 KB-CNS, (plastic)	40
5.2.15	TP 50 KB heated and TP 50 K, (plastic)	42
5.3	Information on accessories	43
5.3.1	Transport safety	43
5.3.2	Transport/serving trolley	44
5.3.3	gastronorm360 OPERATING SYSTEM	45
5.3.4	The mobile catering® kitchen	46
5.3.5	CHECK HACCP	46
5.3.6	Excerpt from the Rieber price guide	46
6	Useful Information on Delivery and Initial Cleaning	47
7	Notes on Use	48
7.1	Safety information with regard to use	48
7.2	Preheating/precooling the thermoport®	50
7.3	Temperature regulation for circulating air heating	51
7.3.1	... with bayonet fitting	51
7.3.2	... with click fitting	53
7.4	Temperature controller for TP actively cooled, (stainless steel)	54
7.5	Active cold holding	55
7.6	Some TPs can be used as bain-maries	55
7.7	Filling containers with food	55
7.8	TP transport	56
7.9	Clean the TP daily after use	57
7.10	Stacking /storage of TPs	57
7.11	Note on permissible changes /modifications	58
8	Cleaning, Maintenance and Care	59
8.1	Safety information relating to cleaning, maintenance and care	59
8.2	Cleaning agents for stainless steel	60
8.3	Choose the correct cleaning method	61
8.4	Overview of intervals	63
8.5	Heated TP	64
8.5.1	Disassembly and installation of the heating unit	64
8.5.2	Keep the heating unit clean	66
8.6	Actively cooled TP, (stainless steel)	66
8.6.1	Disassembly and installation of the circulation fan	66
8.6.2	Keep the ventilation grille clean	67
8.7	Information on cleaning	67
8.8	Note on storage	68
8.9	Keep appliance ready for next use in dry condition	68
9	Operating Faults / Service	69
10	Warranty and Liability	70
11	Manufacturer's address	71

1 Revision Index

Revision	Change
2011-05-06	First issue
2012-02-28	VDE mains power cable, page 21; loading of mobile appliances; excerpt from EC Declaration of Conformity
2013-02-27	Addition to safety instructions
2013-04-04	Implementation of QM measures
2014-11-05	Weights and max. loading added, safety note modified, structure modified according to EN 60335-1
2017-07-05	Additions; adjustment to Rieber price guide
2017-09-21	Adjustable circulating air heating; designation
2017-12-11	Small improvements
2019-02-01	Temperature profile according to DIN EN 12571
2019-11-04_f1	TP 1000 K cool, (made of plastic)
2021-03-10	TP 1600k/2000k/3000k with R290 refrigerant
2021-04-14	Hazard warning R290
2023-04-04	New images
2025-01-13	Refrigerant for refrigeration unit

2 Important Information

thermoport® is frequently abbreviated to TP

2.1 The components of the technical documentation

The documents can be called up via the QR code on your device, type plate.

- Operating Instructions
- Declaration of conformity
- EU safety data sheet for refrigerant
- Cleaning agents for stainless steel
- Choose the correct cleaning method

In addition:

- Spare parts and necessary instructions.
www.rieber.de
Select “→ Customer Service”, at the top of the display bar.
- Do you wish to have the operating instructions in another language?
www.rieber.de
Select “→ Customer Service”, at the top of the display bar.
- Information on CHECK HACCP
www.rieber.de
Select “→ Service”, at the top of the display bar.

2.2 Using this guide

This guide contains important information about how to use the appliance safely and correctly.



- Read the operating instructions before first using the product.
- Keep this guide in a safe place and pass it onto the next owner should you wish to part with the product.

Our customers often express the wish to have one compact guide instead of a number of different guides for these product variants, which have similar functions.

If there are any shortcomings in your opinion, please do not hesitate to let us know. We shall endeavour to become even better with your help.

Please add your notes here 😊

Note the details for your contact at Rieber Customer Service here:



2.3 Representation conventions in the text

- Lists are represented in this way.
- Instructions on certain actions are represented in this way.



The result of the action is represented in this way.



See '...' cross-references are represented in this way.



CAUTION

indicates potential damage to property without any personal injury. Failure to follow these instructions may cause damage to property.



User tip

➤ Useful information or tip

2.4 Structure of safety instructions

The signal words DANGER - WARNING - CAUTION classify the possible degree of risk of bodily injury in an actual situation. You can avoid injury by complying with the behavioural rules provided.

The warning triangle symbol indicates a "General Danger".



DANGER

indicates **imminent danger**.

Failure to follow these warning instructions will result in **serious bodily injury or death**.



WARNING

indicates a **potentially hazardous situation**.

Failure to follow these warnings **may cause serious bodily injury or even death**.



CAUTION

indicates a **potentially harmful situation**.

Failure to follow these warnings **may cause minor bodily injury**.

2.5 Tips on selecting the TP for your specific requirements

The plastic **thermoport**[®] is sturdy enough to meet a wide variety of transport requirements.

The stainless steel **thermoport**[®] is ideal for festive occasions.

Here are the advantages at a glance

- Excellent insulation values
- Gastronorm-compliant
- Hygienic. Smooth surfaces without hidden angles
- Exchangeable floor protection rails
- Doors easy to remove
- The plastic and stainless steel versions of the **Rieber thermoport**[®] can be combined together for stacking and stored on Rieber transport and serving trolleys — for non-slip and safe transport.
- **CHECK HACCP** – the digital system for simple, safe and transparent temperature detection – also retrofittable. In addition to this, further digital features are possible in the areas of hygiene and service management.

 See 'CHECK HACCP', page 46

Abbreviations used

thermoport[®] is frequently abbreviated to **TP**

Brief guide to the type code:

TP	—	thermoport [®]
TP 4.0		... symbolises new generation such as Industry 4.0
TP	6000 —	... the number indicates the size in the order
	3000	
	2000	
	1600	
	1400	
	1000	
	105	
	50	
TP	U	... with circulating air heater /stainless steel TP
TP	DU	... with circulating air heater and lid on top /stainless steel TP
TP	L	... top loader /stainless steel TP
TP	K	... (K) plastic
TP	KB	... (K) plastic / (B) heated
TP	KB -A	... (K) plastic / (B) heated; temperature control without display
TP	KB -D	... (K) plastic / (B) heated; temperature control with digital display
TP	K	... (K) plastic /plastic TP
TP	K cool	... (K) TP made of plastic (cool) with refrigeration unit /circulation fan

3 Safety Instructions

This section covers residual risks and hazards associated with the intended use of the appliance. We have provided a list of all generally valid safety instructions which must be followed.

In the following section, safety information relating to a particular operation or situation is placed before the appropriate operation step or description of the situation.

3.1 General behaviour

This appliance meets the current state of the art and complies with all acknowledged technical safety-related regulations. Nevertheless hazards may still arise.

- Do not use the device as a stepladder or to store objects on.
- Only use this appliance when it is in fault-free condition and according to the instructions in this user guide.
- During all phases of the appliance's life please ensure that the appliance is safely integrated into its environment.
- Do not make any conversions or modifications to the appliance.

3.2 On use of electrical appliances

Safety instructions according to EN 60745-1:

Work area

- Keep your work area clean and tidy. A messy or unlit work area can cause accidents.
- Keep children and other persons at a distance when using the product.

Electrical safety

- The plug on the unit must fit in the socket. Do not modify the plug in any way. Never use an adapter in combination with earthed appliances. Using an unmodified plug and a suitable socket will reduce the risk of an electric shock.
- Avoid bodily contact with earthed surfaces such as pipes, heating units, cookers and refrigerators. The risk of an electric shock is greater when your body is earthed.
- Keep the appliance away from rain or moisture. Allowing water to get into an electric appliance will increase the risk of electric shock.
- When removing food, make sure that no liquids, e.g. sauce, come into contact with the thermoport®. This will increase the risk of an electric shock.
- Do not misuse the cable by using it to remove the plug from the socket. Always remove whilst holding onto the plug. Keep the cable away from heat, oil, sharp edges or the moving parts of other appliances. Using damaged or tangled cables increases the risk of electric shock.
- When working with an appliance outdoors, only use extension cables which are permitted for outdoor use. Using an extension cable suitable for outdoor use reduces the risk of electric shock.
- Potential risk of fire due to heat build-up. Unwind the cable from the cable drum to prevent a possible heat build-up and/or cable fire. The coupling must have splash protection, must be made of rubber or be rubber-coated.

Safety guidelines for persons

- Be attentive and pay attention to what you are doing, act rationally when working with an electrical appliance. Do not use the appliance when tired or under the influence of drugs, alcohol or medication. Just one moment of inattention whilst using the appliance can result in serious injury.
- Make sure the appliance cannot be switched on unintentionally. Double check that the main switch is in the "OFF" position before inserting the plug in the socket. Connecting the appliance to the power supply while it is switched on can cause an accident.

Careful handling and use of electrical appliances

- Keep unused electrical appliances in places where children are not able to reach them. Do not allow the appliance to be used by persons who are not familiar with it or persons who are not familiar with this user guide. Electrical appliances are dangerous when in the hands of inexperienced persons.
- Handle the appliance carefully. Check that moving parts are functioning properly and do not jam; check whether parts are broken or damaged and impairing the functioning of the appliance. Have any damaged parts repaired before using the appliance. Many accidents are caused by poorly-maintained electrical appliances.
- Use electrical appliances, accessories etc. in accordance with these guidelines and in a manner that is specified for this particular appliance type. When using the appliance, please take into account the working conditions and the work being carried out. Using electrical appliances for other uses than that intended can lead to hazardous situations.

Service

- Only have the appliance repaired by qualified and authorised staff. Only use original spare parts. In this way you can ensure that the appliance remains safe.

3.3 Operator's obligations

Operator

The operator is the person who operates the appliance for commercial or economic purposes either himself/herself or lets others use it and bears the legal appliance responsibility for protection of the user, staff or any third parties during operation.

Operator's obligations

The appliance is used in commercial applications. For this reason, the operator of the appliance must meet all legal duties relating to work safety.

In addition to the safety instructions in this guide, the safety, accident prevention and environmental protection regulations applying to the application of the appliance must be complied with.

In particular, the following shall apply:

- The operator must be familiar with the applicable work safety regulations and identify, by carrying out a risk analysis, any additional hazards which are due to the place where the appliance is used. These hazards must be addressed in the form of operating instructions governing the operation of the appliance.
- During the whole service life of the appliance, the operator must verify if the operator's operating instructions reflect the current versions of the applicable regulations. If necessary, the operator must update the operating instructions accordingly.
- The operator must define and assign the responsibilities for installation, operation, repair, maintenance and cleaning clearly.
- The operator must make sure that all personnel working with the appliance have read and understood this guide. In addition, the operator must train the personnel and inform them of the hazards involved at regular intervals.
- The operator must provide the personnel with the necessary protective equipment and make sure that they wear it.

In addition, the operator must ensure that the appliance is always in a perfect technical condition. For this reason, the following shall apply:

- The operator must ensure that the maintenance intervals defined in this guide are obeyed.
- The operator must have all safety equipment checked regularly for completeness and proper function.
- The operator must ensure that the required media connections are available.
- The operator must ensure that all safety-relevant measures required on site are taken.

3.4 Personnel qualification requirements

Safe operation requires certain technical skills and personal qualification of each person.

- The responsibility for organisation lies with the '**designated representative**' (operator). According to EN 50110-1, the designated representative is a 'person assigned the direct responsibility for the performance of the work. If necessary, this responsibility can be assigned partly to other persons. [...] The designated representative must instruct all persons involved in the work on all hazards which may not be obvious for them'.
- The work may only be performed by '**instructed persons**' who have been trained accordingly. Training and instruction must be repeated, and proper understanding must be verified (ideally by way of an appropriate test).
- Only '**qualified personnel**' are allowed to carry out repair work. IEC 60204-1 defines qualified personnel as "persons who, on account of their training and relevant experience are in the position to recognise risks and avoid potentially dangerous situations."
- Electrical work may only be carried out by trained and experienced **electricians**. Electro-technically instructed persons may only work under the supervision of a qualified electrician.
- Work on the cooling unit should only be carried out by authorised skilled personnel such as a **refrigeration specialist** or a member of the Rieber Customer Service.
- The heating unit housing may only be opened/closed for the purpose of thorough cleaning by appropriately trained and authorised operating personnel.
- Any repairs and/or overhaul during the warranty period may only be carried out by the manufacturer's service department.



'Warranty and Liability', page 70

3.5 Provision of personal protective equipment (PPE) for personnel

The requirements for safety shoes are regulated by standards. The safety shoes in this case are intended to protect the toes. S1 safety shoes are protective shoes with the requirement that a protective toecap is present. As with S2 and S3 safety shoes, the protective toecap has a load capacity of 200 joules. These requirements are regulated in EN 20345:2004 for safety shoes.

- Ensure that the personnel wear the personal protective equipment appropriate to the relevant situation.
- Wear sturdy shoes to prevent injuries.
- Wear protective gloves to prevent burns to hands and arms due to contact with the heating unit, which can have a temperature of up to 100 °C.

3.6 Appliance-specific safety instructions

This chapter describes general, appliance-specific safety instructions. In the following section, additional safety information relating to a particular operation or situation is placed before the appropriate operation step or description of the situation.

3.6.1 Risks in transit

Portable thermoport®

- There is a risk of injury when lifting and carrying heavy loads. Such work may only be carried out by suitable and appropriately trained personnel. If you are not physically fit, consult your designated representative.



Chapter 'Information on accessories', page 43 ff., section "MOBILE APPLIANCES" ...little helpers

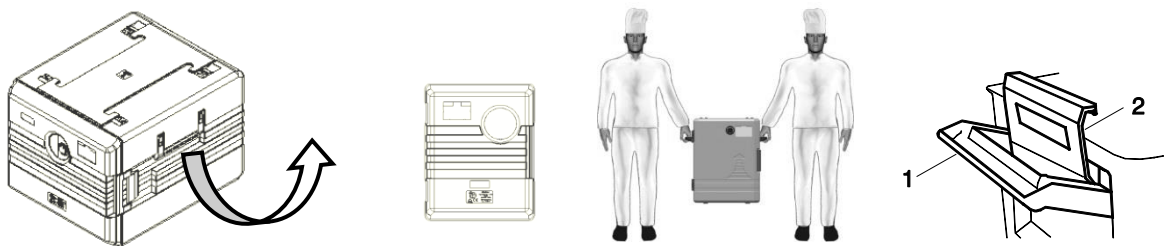

- When transporting the appliance hold it at the handle (1), not the clip lock (2). Hold it at the fold-out carrying handles.

Example

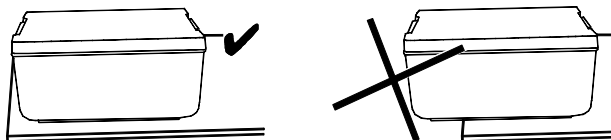

- Position TP securely.
- Ensure stable positioning of the TP with door: Place the appliance far enough back from the installation edge so that when it is emptied the door can rest on the installation surface.
- Only stack matching TP appliances, otherwise there is a risk of tipping and falling. Judge the permissible stack height realistically on your own responsibility. We recommend: Stack 2 stackable TP on top of one another.
- Keep the door/lid closed during transport.

Mobile thermoport®

- Do not pull the appliance, always push it using the pushing handle. This will also give you a better overview and allow direct access to the 'castors with parking brake'. Do not lift the appliance using the pushing handle, as this could cause damage.
- Keep the door/lid closed during transport.
- Only transport the appliance on a level surface if possible.
- Move the appliance with 2 people if necessary.
- Use the two parking brakes to prevent the device from rolling away accidentally. Only place the appliance on level surfaces.
- Wear safety shoes to prevent injuries.
- Mobile appliances may only be moved manually. Machine-aided transport, e.g. using fork lift trucks or lift trucks, is not permissible.



CAUTION

Uneven ground such as edges, ridges or thresholds can damage the castors.

- Only move the appliance over flat, smooth surfaces. Do not push or pull the appliance over sharp edges.
- Note the permissible step height, maximum 4 mm, otherwise the castors may be damaged.
- Do not use this appliance on poor floor conditions. We cannot rule out the possibility of marks appearing on the floor due to friction with castors or the formation of scratches due to split cracks in the castors, for example.

Load safety

According to § 22 of the Road Traffic Regulations (StVO) the load must be stowed and secured in such a way that it cannot slip, fall over, roll, fall off or cause avoidable noise even during emergency braking or if a sudden evasive motion is required. The responsibility for the load safety lies with the driver, the owner and the shipper.

- Secure the load.



See transport safety in chapter 'Information on accessories', page 43

3.6.2 Risks due to electricity

-  **Danger of electric shock. Danger of death.**

Keep the appliance away from rain or moisture.

Risks when handling open liquids and food. Liquid could penetrate the circulating air heater or refrigeration unit.

- Only transport liquids and food in closed condition.
We recommend: Use Gastronorm containers and thermoplates® with Rieber watertight press-in lids.
- Transport the filled TP with electrical connection in the position of use.
- Before cleaning always disconnect the appliance from the power, then dismantle the removable electric heating unit or removable refrigeration unit. **Wipe electrical parts with a slightly damp cloth** and use a dry **cloth to rub dry**.
- Always disconnect the power cable before transporting the appliance; use the mains plug to do this.
- Install the electric cable in such a way that risks like falling over or tearing off the cable, etc. are avoided.

Risks due to soiled heater.

- Do not poke anything into the ventilation grille.
- The heating unit housing may only be opened/closed for the purpose of thorough cleaning by appropriately trained and authorised operating personnel. If necessary, contact the manufacturer's service department.



See 'Personnel qualification requirements', page 10

Risks due to moisture and ambient temperature below +2°C.

- Do not set or store below +2°C, otherwise stray electrical currents may result due to condensation water. Only use in dry areas and ambient conditions. Leakage currents can be dangerous.

Risks in wet areas. The operator is obliged to comply with the legal requirements, for example sockets must be arranged at a height of at least 1 m and have a pre-switched residual current operated device (RCD) with a tripping current of 30 mA.

- Do not use extension cables in wet areas.

3.6.3 Risk of burning and scalding

- Risk of burns from contact with up to 100 °C electric heating. Allow the heating to cool down beforehand, for around 20 minutes. Wear protective gloves.
- Risk of scalds from contact with hot liquid food. Store food in containers and seal with a lid.
- Keep any combustible or explosive fluids away from heated appliances. Otherwise a fire or explosion may occur.

3.6.4 Risks due to refrigerant

- **DANGER!** Refrigerant is an extremely flammable gas.
- Ensure good ventilation if there are a large number of cooled appliances in one place.

3.6.5 Risk of suffocation

- Danger of suffocation if persons get locked in the appliance. Make sure persons with limited sensory and mental ability have no access to the appliance.

3.6.6 Warnings concerning the use of the appliance by children

- This appliance may be used by children over 12 and by persons with limited physical, sensory and intellectual abilities or a lack of experience and/or knowledge if they are supervised or if they have been instructed in the safe use of the appliance and have understood the resulting dangers.
- When using the appliance with 'accessories', other risks may arise.
- Children may not play with the appliance.
- Cleaning and user maintenance may not be carried out by children without supervision.

3.6.7 Safety and monitoring devices

- In the event of a fault in the control or electrical system the appliance switches itself off, alternatively the maximum permissible temperature is not exceeded.
- The circulating air heaters with bayonet fitting are unmistakable thanks to the arrangement of the keyholes.
- Hot steam can escape even when the steam valve in the door of the heated stainless steel TP is closed. Allow more steam to escape before opening the door if necessary, by opening or turning the steam valve.
- The plastic cover fits positively, small gap width. Steam can escape, pressure equalisation is ensured.
- To increase your safety we recommend that you install a residual current device with a tripping current of 30 mA upstream of the appliance.
- Push handle on mobile TP: Do not pull the appliance, always push it using the pushing handle. This will also give you a better overview and allow direct access to the 'castors with parking brake'.
- The connection cable is heat-resistant up to 120 °C and cannot be confused due to the shape of the connector.
- The plastic and stainless steel versions of the **Rieber thermoport**[®] can be combined together for stacking and stored on Rieber transport and serving trolleys — for non-slip and safe transport.



*Chapter 'Information on accessories', page 43 ff.,
section "MOBILE APPLIANCES" ...little helpers"*

3.6.8 Please observe the product identification, make sure it is safely maintained

The type plate on the appliance bears the legally required product data.

NOTE: If the product identification is damaged or illegible, the warranty will be invalidated. Contact Rieber Service as early as possible in the event of damage.

Heating unit with bayonet fitting

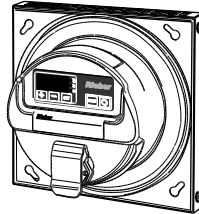
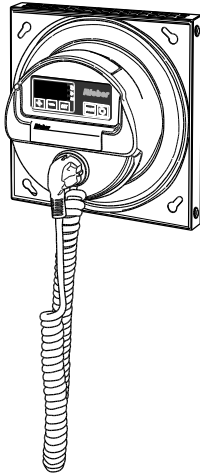

The following is indicated on the back:
→ Danger of electric shock. Danger of death.

- Hot surface
- Keep away from moisture
- Observe the operating instructions

Heating unit with click fitting



The following is indicated on the back:
→ Danger of electric shock. Danger of death.

- Hot surface
- Keep away from moisture
- Observe the operating instructions

Bain-marie

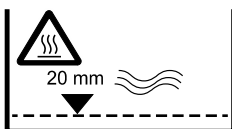

The following is indicated on the top of the container:
→ Hot surface

- For 'wet heating' pour 2 cm of water into the bain-marie

Bain-marie

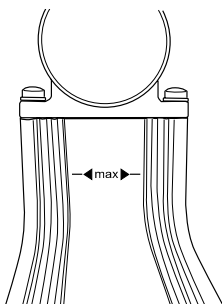

The following is indicated on the heater element:
→ Maximum water level

- Hot surface
- Protection class IPX3. Protection against falling spray water up to 60 ° from vertical
- Observe the operating instructions



H-BM R 0050 → relates to heated TP 50 KB

H-BM R 0100 → relates to heated TP100 KB

Identification on the refrigeration unit



The protective cover is sealed.
The refrigeration unit is identified with a hazard symbol.

3.7 Information about regulations to be followed

Alongside this user guide there are a range of health and safety and other regulations that are relevant for the operation of this cooking station; these include HACCP food hygiene regulations, for example.

Maximum hot holding time according to HACCP is 2 hours.

3.8 Instructions on behaviour in an emergency

- In an emergency always interrupt the power connection immediately, by disconnecting the electrical connector.

First aid in the case of burns, scalds, crushing or electric shock:

- Inform yourself on this before commissioning the appliance.
- Store the emergency equipment, including the relevant instructions, at a readily accessible place near the place of use. Make yourself familiar with the instructions.

User tip

- You can find detailed information in the company's internal instructions.
- We recommend that half-yearly emergency training sessions should be carried out.

4 Designated Use

This chapter provides information on the intended use of the product and warns against foreseeable misuse or abuse, for your safety. Use the appliance for its intended use.

⚠ Intended use in principle means:

- For meal services in catering, hotels and restaurants; also for managed care facilities and schools. For food delivery / food distribution. Not intended for private use at home.
- Only transport food and liquids closed. Protect thermoport® electrical appliances against moisture, otherwise liquid could penetrate the circulating air heater or the refrigeration unit, for example. We recommend: Use containers with watertight press-in lids such as thermoplates® and Gastronorm containers from Rieber.
- Transport TP in its working position.
- The loaded TP may only be carried / lifted by suitable, trained personnel.
- Only transport the appliance in its correct position (operating position). We recommend: Stack no more than 2 stackable TP on top of one another. When stacking, ensure that the guide rails of both devices slot into one another.
- To prevent injuries such as burns on hot surfaces, use of the product by the public or for self-service should only be allowed under supervision. Wear personal protective equipment to prevent burns and scalds.
- To avoid the risk of scalds, transport the appliance horizontally. Observe the permissible water level according to the product identification. Open the lid carefully.
- Remove the heating unit before cleaning the heatable appliance. Allowing water to get into an electric appliance will increase the risk of electric shock.
- Heat or cool the TP in a heating cabinet or cold store as required, in the range between +2 °C and +85 °C.
- The intended use includes compliance with the technical data.
- The designated representative, for example the chef, defines how the TP is actually used and is responsible for such use.
- For use only by appropriately trained and suitable operating personnel.

thermoport®

- The TP is intended for the thermally-insulated transportation of heated or chilled foods. Transport of prepared meals. Transport TP with closed door/lid and mains plug disconnected.

thermoport® with circulating air heater

The radiant heat ventilation produces an intensive uniform air flow.

- For thermally-insulated hot holding of food. More uniform temperature distribution by adjustable electric heating and circulating air controller.

thermoport® with heating function /static radiant heat

The radiant heat on the heating surface produces an air current. Examples: TP 100 KB-CNS with surface heating in the floor and side area of the carcass and TP 100 KB with rod heating.

- For thermally-insulated hot holding of food.

thermoport® for cold holding

Cold holding with cooling pellets or TP actively cooled.

- For keeping chilled meals and beverages cold. Keeping cold at +2 °C to +8 °C. Keeping pre-chilled food at storage temperature.
- Do not place the appliance close to heat sources.
- Move and chill the food correctly daily after use, switch off and clean the appliance.

Prevent any predictable misuse and abuse:

- Protect thermoport® electrical appliances against moisture, otherwise liquid could penetrate the circulating air heater or the refrigeration unit, for example. Therefore only transport food and liquids closed.
- Only stack matching TP appliances, otherwise there is a risk of them tipping and falling. Judge the permissible stack height realistically on your own responsibility.
- Ensure stable positioning of the TP.
Example for size 1000: For one appliance, place this far enough back from the installation edge so that when it is emptied the door can rest on the installation surface.
- Transport TP with closed door/lid and mains plug disconnected.
- Always use the mains plug when disconnecting the connection cable. Do not pull the cable.
- Do not use the TP as a storage surface for hot transport containers.
- Do not throw the TP, but handle it with care.
- Do not use the TP as a stepladder.
- Do not place the TP on a hot cooker or on angled surfaces.
- Do not place the TP inside the oven or heat it up.
- Do not use the TP to heat or cool rooms.
- Do not cover the heater with cloths or similar items.
- Secure the thermoport® in position during transport.



See transport safety in chapter 'Information on accessories', page 43

- Keep water spray, particularly steam jet cleaners, away from electrical parts of the TP as well as the heater and cooling device.
- Keep any combustible or explosive fluids away from heated appliances. Otherwise a fire or explosion may occur. Do not keep meals with a high proportion of strong alcoholic beverages hot.
- Do not use stainless steel appliances in aggressive ambient conditions, for example extremely salt-laden air such as close to the sea or at a swimming pool with a chlorinated atmosphere, as this could damage the stainless steel.
- Do not pull or push the appliance over sharp edges, danger of material damage.
- Do not use this appliance on poor floor conditions.
We cannot rule out the possibility of marks appearing on the floor due to friction with castors or the formation of scratches due to split cracks in the castors, for example. We cannot rule out the possibility that the castors may be damaged or become unusable due to thresholds or sharp edges on the floor.
- Mobile appliances may only be moved manually. Machine-aided transport, using fork lift trucks or lift trucks, is not permitted.
- Do not use the heating unit of the heated TP for other purposes, for example to heat other containers or as an exposed space heater.

5 Description of the Appliance

This chapter contains useful facts about the set-up and functionality of this appliance.

5.1 Designation

Identification of components

The parts which are important for understanding the subsequent sections are identified in the following.

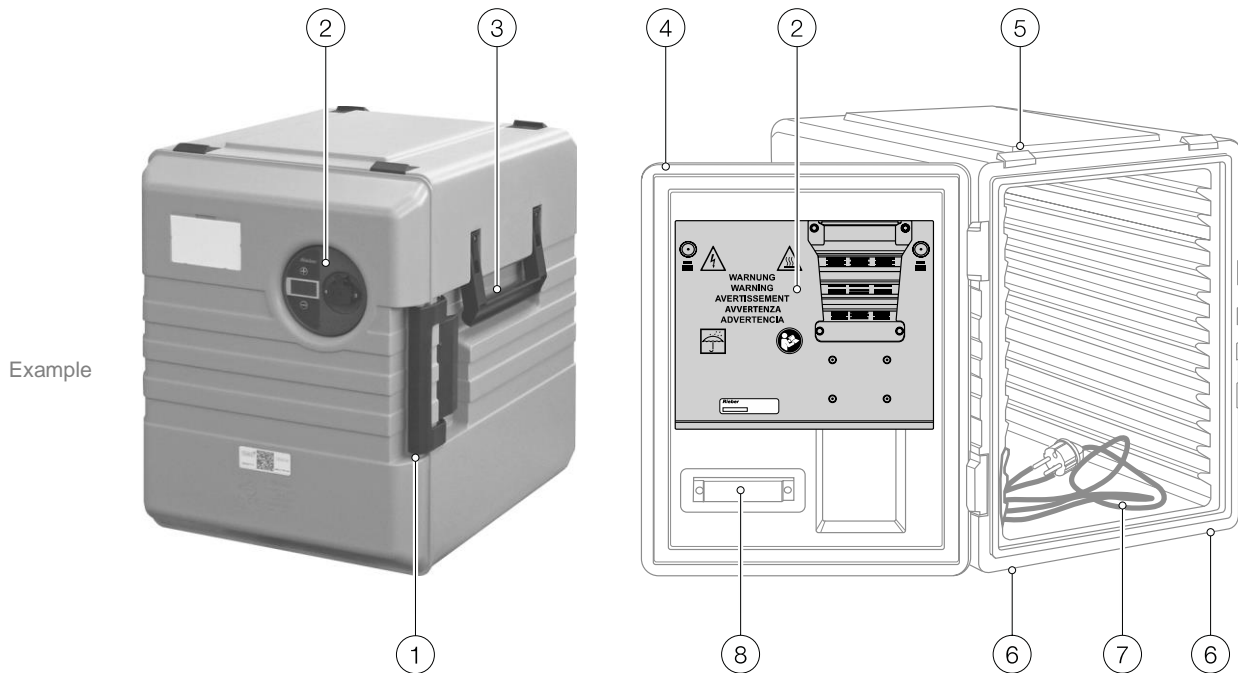

TP 1000 KB heated with digital circulating air heater

- | | |
|---|-------------------------|
| 1 Door lock | 6 Stacking runner |
| 2 Circulating air heater | 7 Mains cable, internal |
| 3 Handle for lifting the appliance, on both sides | 8 CHECK sensor (option) |
| 4 Door | |
| 5 Stacking corners | |

5.2 Technical data

5.2.1 General data

5.2.1.1 Electrical connection

Rated voltage / mains frequency	1N AC 230 V 50/60 Hz
Electrical connection	Around 2 m cable length; type H05RN-F 3x1.0 mm ²

5.2.1.2 Protection class

Protection class for heated TP

Protection class for TP in working condition with mains plug inserted	IPX4 according to DIN EN 60529 → Protection against water splashes on all sides
Protection class for heating unit in disassembled condition	IPX3 according to DIN EN 60529 → Protection against falling spray water up to 60° from vertical

Protection class for stainless steel TP for cold holding with active circulating air cooling

Protection class for TP in working condition with mains plug inserted	IPX4 according to DIN EN 60529 → Protection against water splashes on all sides
Protection class for circulation fan in disassembled condition	IPX3 according to DIN EN 60529 → Protection against falling spray water up to 60° from vertical

5.2.1.3 Housing

Housing / door / lid	Made of chromium-nickel steel: Carcass with double-wall insulation, interior seal-welded. Door / lid have an elastic seal. The seal is removable. Temperature-resistant between -20 °C and +85 °C. Made of plastic: Non-porous plastic skin, seal-welded. The plastic cover fits positively, small gap width. Temperature-resistant from -20 °C to +85 °C.
Mobile appliance	4 corner guards. Plastic castors, wheel diameter 125 mm. 2 steering and 2 swivel castors. Stainless steel castors and antistatic tyres on request.

5.2.1.4 Data for heated TP and actively cooled TP

Heated TP ¹

Circulating air heater for stainless steel TP.

... with bayonet fitting

Order no.: 55 05 02 56

Heating temperature can be regulated between +20 °C and +100 °C.

TPs with circulating air heating produce a more even heat distribution.

→ Applies to: TP 3000 U, TP 2000 U, TP 3000 hybrid, TP 1600 DU, TP 1600 U, TP 1400 U, TP 1000 DU, TP 1000 H



Page 51

Circulating air heater for plastic TP.

... with bayonet fitting

Option can be ordered separately as a spare part,

Order no.: 55 05 02 55

Heating temperature can be regulated between +20 °C and +85 °C.

TPs with circulating air heating produce a more even heat distribution.

→ Applies to: TP 4.0 1000 KB circulating air



Page 51

Circulating air heater for plastic TP.

... with click fitting

Order no.: 55 05 02 60

Heating temperature up to +85 °C. There is no adjustment option.

TPs with circulating air heating produce a more even heat distribution.

→ Applies to: TP 6000 KB, TP 1000 KB-A, TP 600 KB-A



Page 53

Circulating air heater for plastic TP.

... with click fitting

Option can be ordered separately as a spare part,

Order no.: 55 05 02 61

Heating temperature can be regulated between +20 and +85 °C.

TPs with circulating air heating produce a more even heat distribution.

→ Applies to: TP 6000 KB-D, TP 1000 KB-D, TP 600 KB-D



Page 53

Surface heating in floor and around 2/3 height at sides

Heating temperature up to +85 °C. There is no adjustment option.

TP with surface heating.

→ Applies to: TP 105 L, TP 100 KB-CNS

Can be used as bain-marie together with GN-containers.

Rod heating

Order no.: 55 05 02 14

Heating temperature up to +85 °C. There is no adjustment option.

TP with rod heating

→ Applies to: TP 100 KB, TP 50 KB

Can be used as bain-marie together with GN-containers.

TP actively cooled

Cold holding

+2 °C to +8 °C with closed door

Refrigerant

See information on type plate, QR code

NOTE:

Stainless steel TP for cold holding with active circulating air cooling.

→ Applies to: TP actively cooled, mobile, made of stainless steel

In principle all TPs can be passively cooled with cooling pellets.

Cold holding means: Keeping pre-chilled food at storage temperature.



'Preheating/precooling the thermoport[®]', page 50

¹ Abbreviations used: See chapter 2.5

5.2.1.5 Hygienic design

- TP 1600 DU in hygienic design H2
- All other thermoport® in H3 hygienic design
(compliant with DIN 18865-9:1997 Food distribution equipment, Part 9.)

Hygienic design **H3** means: Floor, walls and cover welded tightly and gap-free.
All curvatures ≥ 10 mm.

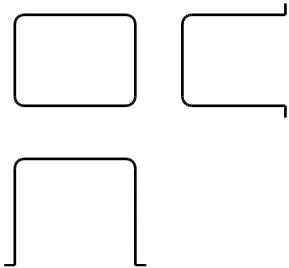

5.2.1.6 Insulating behaviour of thermoport®

Measurement according to DIN EN 12571

→ See diagrams on the following pages.

Temperature profile for hot holding (hot operating condition)

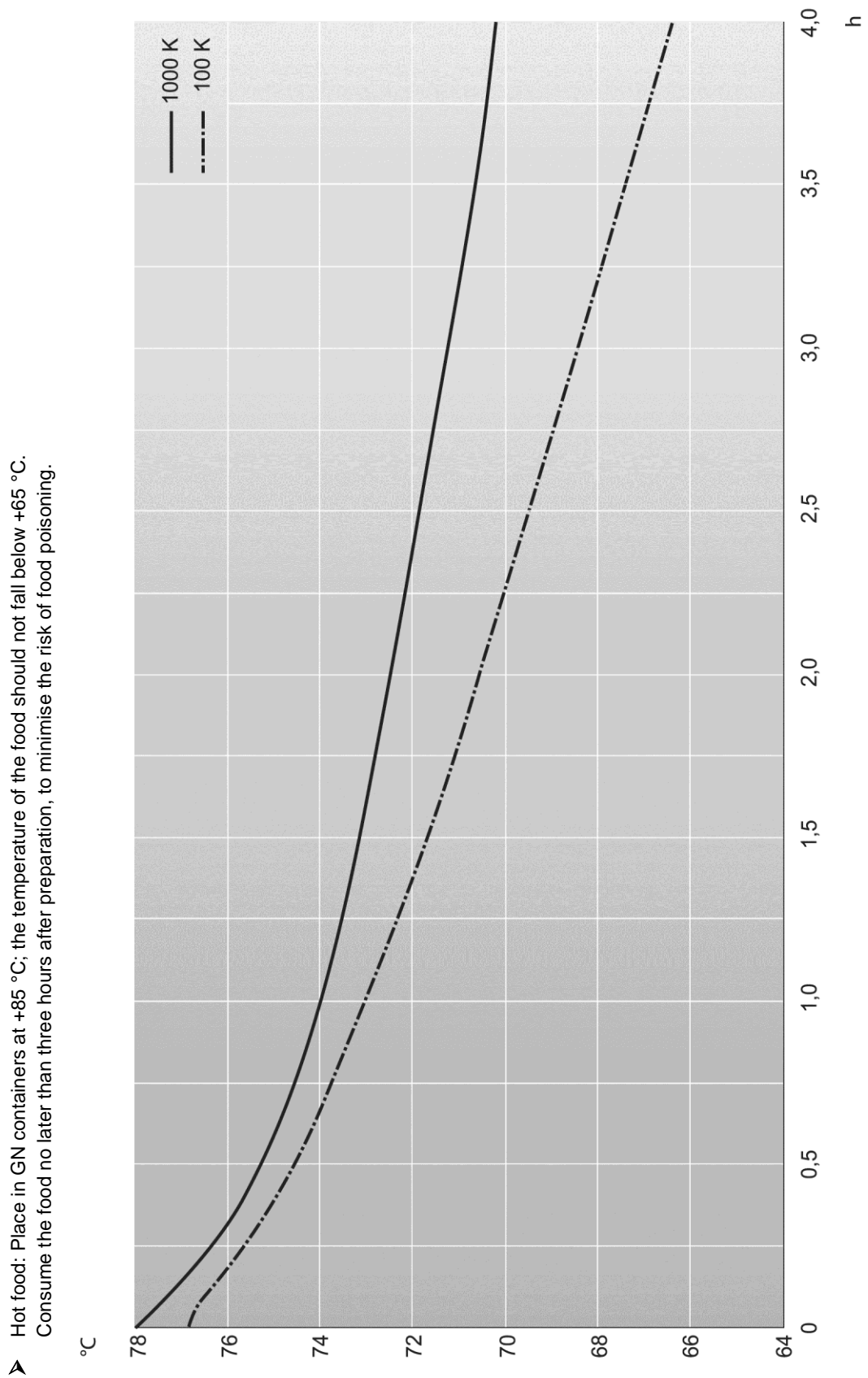

Temperature profile for cold holding (cold operating condition)

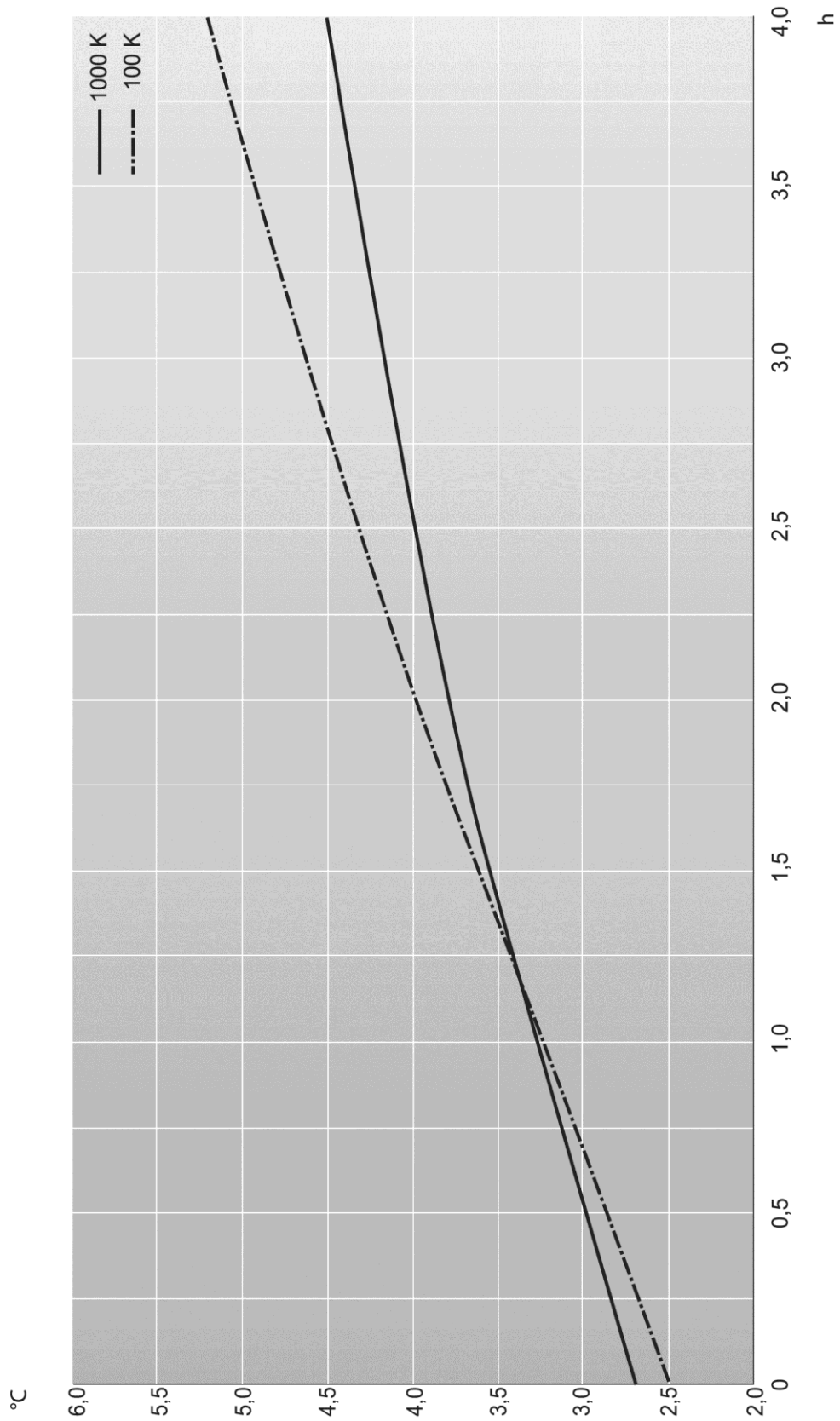

Temperature profile for keeping food deep-frozen (deep-freeze operating condition)

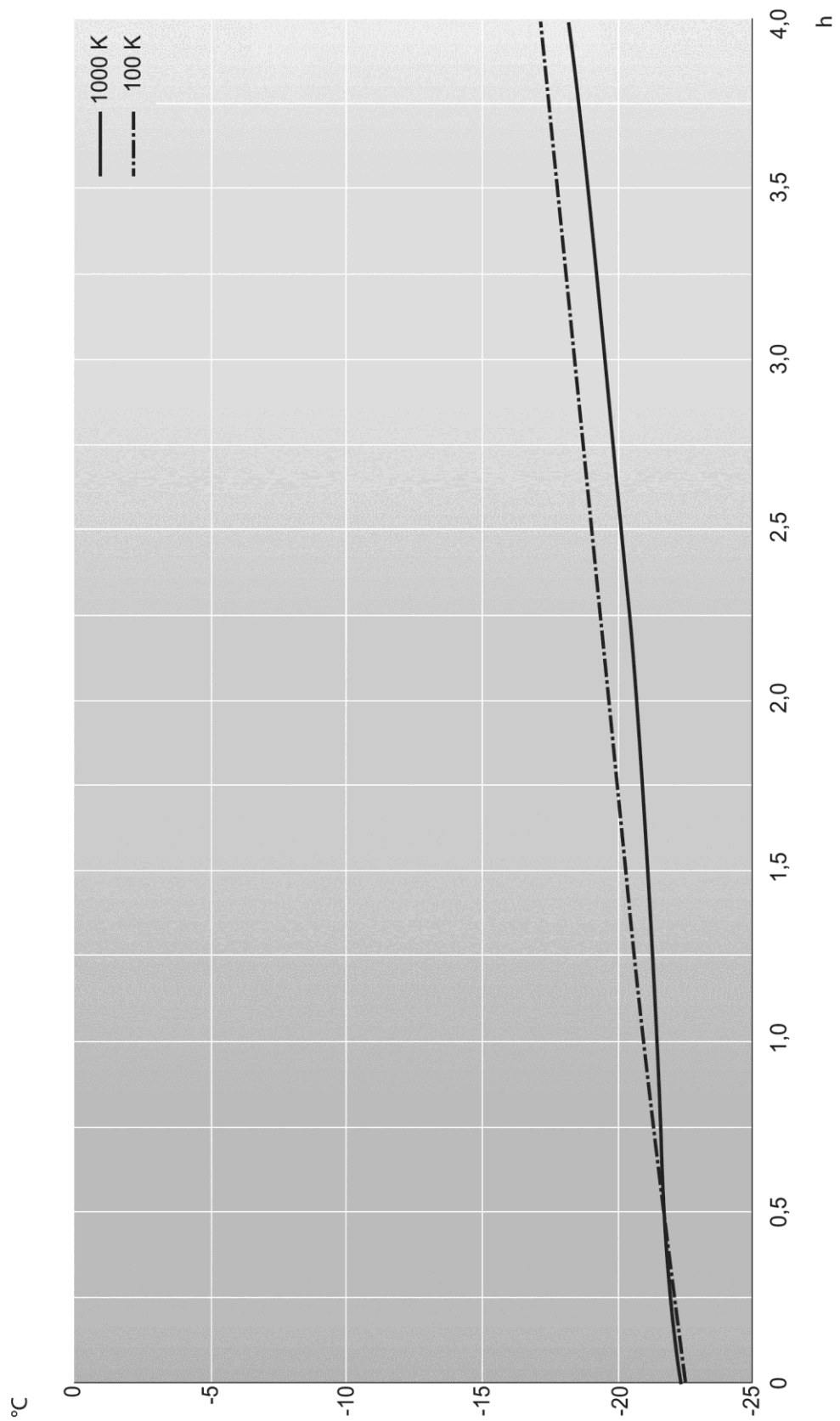

5.2.2 TP 3000 U heated and TP 3000, (stainless steel)





3000 U heated
– circulating air heater



3000

Support rails: 30 pairs (seamlessly deep-drawn)

Configuration example: 5 x GN 1/1 200 mm

Designation Order no.	Load capacity, max. [litres]	Heating capacity [W]	Outer dimensions L x W x H [mm]		
TP 3000 U heated 85 01 08 08 without CHECK 85 01 08 14 with CHECK	130	763 110 V version on request	592 x 769 x 1448	63	150
TP 3000 85 01 08 07 without CHECK 85 01 08 13 with CHECK	130	—	592 x 769 x 1448	59	150

Accessories:

Cooling pellet stainless steel GN 1/1: 324 x 529 x 12.5 mm, asymmetrical

Cooling pellet stainless steel GN 1/1: 324 x 527 x 30 mm

Heating pellet stainless steel GN 1/1: 324 x 529 x 12.5 mm, asymmetrical

Insert frame with 1 long support for GN 4 x 1/4, 6 x 1/6 or 2 x 2/4

Insert frame with 2 cross supports for GN 9 x 1/9 or 6 x 1/6

Antistatic wheels, 4 pcs., diameter 125 mm

Order no.

85 01 20 15

85 01 20 02

89 08 01 72

85 01 20 09

85 01 20 10

On request



Further information: See Rieber price guide,
www.riber.de
Search: Price guide

5.2.3 TP 2000 U heated and TP 2000, (stainless steel)



2000 U heated
– circulating air heater



2000

Support rails: 20 pairs (seamlessly deep-drawn)

Configuration example: 3 x GN 1/1 200 mm; 1 x GN 1/1 100 mm

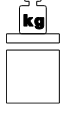
Designation Order no.	Load capacity, max. [litres]	Heating capacity [W]	Outer dimensions L x W x H [mm]		
TP 2000 U heated 85 01 07 08 without CHECK 85 01 07 16 with CHECK	89.7	763 110 V version on request	492 x 769 x 1078	50	150
TP 2000 85 01 07 07 without CHECK 85 01 07 15 with CHECK	89.7	—	492 x 769 x 1078	46	150

Accessories:



See accessories on page 26

5.2.4 TP 3000 hybrid warm/cold active and warm/cold passive, (stainless steel)





TP 3000 hybrid warm active/cold active
 – circulating air heater
 – with active cooling



TP 3000 hybrid warm active/cold passive
 – circulating air heater
 – cooling with cooling pellets

Support rails: 16 pairs (seamlessly deep-drawn) for warm
 8 pairs (seamlessly deep-drawn) for cold

Configuration example: 6 x GN 1/1 100 mm for warm;
 1 x GN 1/1 200 mm + 1 x GN 1/1 150 mm for cold

Designation Order no.	Load capacity, max. [litres]	Heating capacity/ refrigeration capacity [W]	Outer dimensions L x W x H [mm]		
TP 3000 hybrid warm active/cold active (with active cooling) 85 01 08 17 without CHECK 85 01 08 19 with CHECK	70 (warm) 44 (cold)	763 180	592 x 769 x 1648	78	150
TP 3000 hybrid warm active/cold passive (cooling with cooling pellets) 85 01 08 16 without CHECK 85 01 08 18 with CHECK	70 (warm) 44 (cold)	763 —	592 x 769 x 1448	64	150

Accessories:

 See accessories on page 26

5.2.5 TP 1600 DU heated and TP 1600 U heated, and TP 1600, (stainless steel)



TP 1600 DU heated
– circulating air heater
– with lid





TP 1600 U
– circulating air heater



TP 1600

Support rails: 16 pairs (seamlessly deep-drawn)

Configuration example: 3 x GN 1/1 200 mm
2 x GN 1/1 200 mm, 1 x GN 1/1 150 mm

Designation Order no.	Load capacity, max. [litres]	Heating capacity [W]	Outer dimensions L x W x H [mm]		
TP 1600 DU heated 85 01 09 03 without CHECK 85 01 09 08 with CHECK	78	763 110 V version on request	492 x 769 x 963	47	150
TP 1600 U heated 85 01 06 09 without CHECK 85 01 06 04 with CHECK	70.4	763	492 x 769 x 930	45	150
TP 1600 85 01 06 08 without CHECK 85 01 06 13 with CHECK	70.4	—	492 x 769 x 930	41	150

Accessories:



See accessories on page 26

5.2.6 TP 1400 U heated and TP 1400, (stainless steel)





TP 1400 U heated
– circulating air heater



TP 1400

Support rails: 14 pairs (seamlessly deep-drawn)
 Configuration example: 2 x GN 1/1 200 mm
 1 x GN 1/1 100 mm

Designation Order no.	Load capacity, max. [litres]	Heating capacity [W]	Outer dimensions L x W x H [mm]		
TP 1400 U heated 85 01 11 02 without CHECK 85 01 11 04 with CHECK	63.7	763	492 x 769 x 793	42.5	75
TP 1400 85 01 11 01 without CHECK 85 01 11 03 with CHECK	63.7	—	492 x 769 x 793	38.5	75

Accessories:

 See accessories on page 26

5.2.7 TP 1000 DU, TP 1000 H and TP 1000 N, (stainless steel)



TP 1000 DU heated
– circulating air heater



TP 1000 H heated
– circulating air heater



TP 1000 N



Support rails:

7 pairs (seamlessly deep-drawn) → for TP 1000 DU

8 pairs (seamlessly deep-drawn) → for TP 1000 H, TP 1000 N

Configuration example: 2 x GN 1/1 200 mm → for TP 1000 DU

1 x GN 1/1 200 mm, 1 x GN 1/1 150 mm → for TP 1000 H, TP 1000 N

Designation Order no.	Load capacity, max. [litres]	Heating capacity [W]	Outer dimensions L x W x H [mm]		
TP 1000 DU heated 85 01 05 03 without CHECK 85 01 05 04 with CHECK	52	763	410 x 645 x 530	32	80
TP 1000 H heated 85 01 04 05 without CHECK 85 01 04 09 with CHECK	44.4	763	410 x 655 x 470	20	80
TP 1000 N 85 01 04 04 without CHECK 85 01 04 08 with CHECK	44.4	—	410 x 655 x 470	17	80

Accessories:

Stainless steel chassis

460 x 670 x 305 mm

Stainless steel with plastic corner bumpers, 2 swivel castors and 2 plastic fixed castors,
diameter 125 mm, weight 7 kg



Further information: See accessories on page 26, 43

Order no.



88 14 01 07

5.2.8 TP 105 L, (stainless steel)



TP 105 L heated
 – Surface heating in floor area of carcass and around 2/3 height of sides

Support rails: —
 Configuration example: 1 x GN 1/1 200 mm

Designation Order no.	Load capacity, max. [litres]	Heating capacity [W]	Outer dimensions L x W x H [mm]		
TP 105 L heated ² 85 01 03 02 without CHECK with CHECK on request	26	500	400 x 600 x 306	13.5	45

² All-round external physiologically safe seal. Hygienic design H2

5.2.9 TP actively cooled, (mobile, made of stainless steel)



TP 3000 K cooled
– with circulation fan

TP 2000 K cooled
– with circulation fan

TP 1600 K cooled
– with circulation fan

TP 1000 C cooled
– with circulation fan

Support rails:

30 pairs (seamlessly deep-drawn) → for TP 3000 K cooled

20 pairs (seamlessly deep-drawn) → for TP 2000 K cooled

16 pairs (seamlessly deep-drawn) → for TP 1600 K cooled

8 pairs (seamlessly deep-drawn) → for TP 1000 K cooled



Configuration example:

5 x GN 1/1 200 mm → for TP 3000 K cooled

3 x GN 1/1 200 mm, 1 x GN 1/1 100 mm → for TP 2000 K cooled

2 x GN 1/1 200 mm, 1 x GN 1/1 150 mm → for TP 1600 K cooled

1 x GN 1/1 200 mm, 1 x GN 1/1 150 mm → for TP 1000 C cooled

Designation Order no.	Load capacity, max. [litres]	Connected load Refrigerating capacity [W]	External dimensions L x W x H [mm]	Weight	
				 [kg]	 [kg]
TP 3000 K actively cooled 85 01 08 10 cooled EisfinkD2 85 01 08 20 cooled R290 85 01 08 21 cooled R290 Ø160 85 01 08 22 cooled R290 Ø125 85 01 08 23 hybr. ak. - W&ak - K R290 85 01 08 24 hybr. ak. - W&ak - K R290 br.	130	170 180 at VT -10 °C	592 x 769 x 1648	100	130
TP 2000 K actively cooled 85 01 07 10 cooled EisfinkD2 85 01 07 18 cooled R290 85 01 07 19 gek&ak R290 br.	89.7	170 180 at VT -10 °C	492 x 769 x 1278	80	85
TP 1600 K actively cooled 85 01 06 10 cooled EisfinkD2 85 01 06 16 cooled R290 85 01 06 19 cooled R290 br.	70.4	170 180 at VT -10 °C	492 x 769 x 1130	50	62
TP 1000 C actively cooled 85 01 04 11 cooled R290	44.4	250	410 x 655 x 760	37	44

85 01 04 12 cooled EisfinkD2
85 01 04 13 KatS

119 at VT -10 °C



TP 1000 C cooled
– with circulation fan
KatS

Abbreviations used:

D2	Refrigerant EisfinkD2
R290	Refrigerant R290
br.	Wider platform
Ø160	Castor diameter 160 mm
gek&ak	cooled & active
hybr. ak.	hybrid active
W&ak	warm & actively cooled
KatS	Disaster control

Accessories:

- Insert frame with 1 long support for GN 4 x 1/4, 6 x 1/6 or 2 x 2/4
- Insert frame with 2 cross supports for GN 9 x 1/9 or 6 x 1/6
- Antistatic wheels, 4 pcs., diameter 125 mm

Order no.

85 01 20 09

85 01 20 10

On request



*Further information: See Rieber price guide,
www.rieber.de
Search: Price guide*



Insert frame with 1 long support for GN

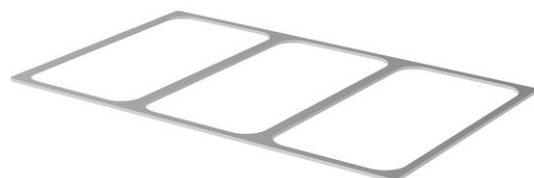

Insert frame with 2 cross supports for GN

5.2.10 TP6000 Maxi for banquet solutions, (mobile, made of plastic)

Example





TP 6000 KB Maxi (heated), (- circulating air heater),
TP 6000 K Maxi (unheated), mobile

TP 6000 K Maxi (unheated),
TP 6000 K Maxi (unheated), mobile

2 x thermoport® comprising non-porous plastic skin, fixed,
with fitted castors, diameter 125 mm at bottom of TP

Support rails: 12 pairs (seamlessly deep-drawn)

Configuration example: 8 x GN 1/1 200 mm

Designation Order no.	Load capacity, max. [litres]	Heating capacity [W]	Outer dimensions L x W x H [mm]		
TP 6000 Maxi KB heated, mobile without CHECK: 85 02 08 04 orange 85 02 08 07 black with CHECK on request	104 104	500 —	766 x 790 x 1280	59.7	75
TP 6000 Maxi K, mobile without CHECK: 85 02 08 02 orange 85 02 08 12 black with CHECK on request	104 104	— —	766 x 790 x 1280	56.5	75

	Order no.
Accessories:	
Grid GN 2/1, stainless steel lightweight version	84 14 01 06
Insulated divider → for TP 6000 K unheated	85 02 20 12 orange 85 02 20 69 black
Cooling pellet GN 1/1 plastic for TP 6000 K unheated	85 02 20 38 orange 85 02 20 67 black
Warming pellet stainless steel GN 1/1: 324 x 529 x 12.5 mm, asymmetrical	89 08 01 72
Insert frame with 1 long support for GN 4 x 1/4, 6 x 1/6 or 2 x 2/4	85 01 20 09
Insert frame with 2 cross supports for GN 9 x 1/9 or 6 x 1/6	85 01 20 10
Tray rack 6000 for EURO baker dimension (option), stainless steel, to take inserts with dimensions 600 x 400 mm, 8 pairs of support rails	85 02 20 44
Stacking lock	85 02 20 61



*Further information: See Rieber price guide,
www.rieber.de
Search: Price guide*

Example



Grid GN 2/1, stainless steel



Insulated divider

Example

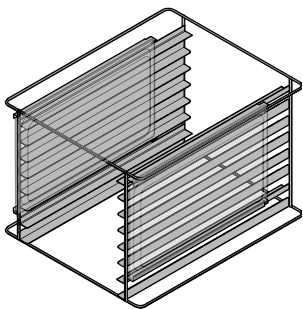

Tray rack 6000
– acceptance of pellets on both sides



Stacking lock

5.2.11 TP 6000 KB heated and TP 6000 K, (plastic)





TP 6000 KB heated
– circulating air heater



TP 6000 K

Support rails: 12 pairs (seamlessly deep-drawn)

Configuration example: 4 x GN 1/1 200 mm

Designation Order no.	Load capacity, max. [litres]	Heating capacity [W]	Outer dimensions L x W x H [mm]		
TP 6000 KB-A heated without CHECK: 85 02 08 13 orange 85 02 08 14 black with CHECK on request	104	500	645 x 790 x 560	23	75
TP 6000 KB heated without CHECK: 85 02 08 15 orange 85 02 08 16 black with CHECK on request					
TP 6000 K without CHECK: 85 02 08 01 orange 85 02 08 05 black with CHECK on request	104	—	645 x 790 x 560	21	75

Accessories:

Insulated divider

→ for TP 6000 K unheated

Cooling pellet GN 1/1 plastic

→ for TP 6000 K unheated

Warming pellet stainless steel GN 1/1: 324 x 529 x 12.5 mm, asymmetrical

Insert frame with 1 long support for GN 4 x 1/4, 6 x 1/6 or 2 x 2/4

Insert frame with 2 cross supports for GN 9 x 1/9 or 6 x 1/6

Stacking lock

Rustproof castors

Tray rack for TP 6000

Stainless steel, to take inserts with dimensions 600 x 400 mm, 8 pairs of support rails

Order no.

85 02 20 12 orange
85 02 20 69 black

85 02 20 38 orange
85 02 20 67 black

89 08 01 72

85 01 20 09

85 01 20 10

85 02 20 61

88 14 01 04

85 02 20 44

5.2.12 TP 4.0 1000 KB circulating air and TP 1000 K, (plastic)



TP 1000 KB heated
– circulating air heater



TP 1000 K

Support rails: 12 pairs (seamlessly deep-drawn)

Configuration example: 2 x GN 1/1 200 mm

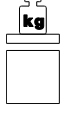
Designation Order no.	Load capacity, max. [litres]	Heating capacity [W]	Outer dimensions L x W x H [mm]		
Heated TP 1000 KB with digital circulating air heater without CHECK: 85 02 04 23 orange 85 02 04 24 black with CHECK: 85 02 04 26 orange 85 02 04 28 black	52	763	435 x 688 x 561	17.6	65
TP 1000 K without CHECK: 85 02 04 01 orange 85 02 04 12 black with CHECK: 85 02 04 25 orange 85 02 04 27 black	52	—	435 x 688 x 561	12	65

Accessories:

Chassis KS

 Page 44 ff.

 Further information: Page 37

Order no.

88 14 01 05

88 14 01 06

5.2.13 TP 600 KB and TP 600 K, (plastic)





TP 600 KB heated
– circulating air heater



TP 600 K

Support rails: 7 pairs (seamlessly deep-drawn)

Configuration example: 1 x GN 1/1 200 mm
1 x GN 1/1 65 mm

Designation Order no.	Load capacity, max. [litres]	Heating capacity [W]	Outer dimensions L x W x H [mm]		
TP 600 KB heated without CHECK: 85 02 05 24 orange 85 02 05 25 black with CHECK on request	33	240	420 x 645 x 390	11	45
TP 600 K without CHECK: 85 02 05 05 orange 85 02 05 18 black with CHECK on request	33	—	420 x 645 x 386	9.2	45

Accessories:

Insert frame with 1 long support for GN 4 x 1/4, 6 x 1/6 or 2 x 2/4

Order no.

85 01 20 09

Insert frame with 2 cross supports for GN 9 x 1/9 or 6 x 1/6

85 01 20 10

Chassis KS

88 14 01 05

 Page 44 ff.

88 14 01 06

Cooling pellet GN 1/1 plastic

85 02 20 38 orange
85 02 20 67 black

Warming pellet stainless steel GN 1/1: 324 x 529 x 12.5 mm, asymmetrical

89 08 01 72

Insulated divider

85 02 20 12 orange
85 02 20 69 black



Further information: See Rieber price guide,
www.riber.de
Search: Price guide

5.2.14 TP 100 K hybrid, TP 100 KB heated, TP 100 K, TP 100 KB-CNS, (plastic)



TP 100 K hybrid
– passive cooling with insulated divider





TP 100 KB heated
– rod heating, statically heated
– dry and wet
TP 100 K



TP 100 KB-CNS heated
– internal muffle comprising chromium-nickel steel
– surface heating

Support rails: —

Configuration example: 2 x GN 2/3 065, 2 x GN 2/3 055, 2 x GN 1/3 065, 1 x GN 1/3 100
→ for TP 100 K hybrid.
1 x GN 1/1 200 mm → for TP 100 KB heated and TP 100 K

Designation Order no.	Load capacity, max. [litres]	Heating capacity [W]	Outer dimensions L x W x H [mm]		
TP 100 K hybrid without CHECK: 85 02 03 53 orange 85 02 03 54 black with CHECK: 85 02 03 60 orange 85 02 03 61 black	26	—	690 x 425 x 364	8	40
TP 100 KB heated without CHECK: 85 02 03 13 orange 85 02 03 29 black with CHECK: 85 02 03 57 orange 85 02 03 58 black	26	240	370 x 645 x 308	8.3	40
TP 100 K without CHECK: 85 02 03 01 orange 85 02 03 28 black with CHECK: 85 02 03 55 orange 85 02 03 56 black	26	—	370 x 645 x 308	7.2	40
TP 100 KB-CNS heated without CHECK: 85 02 03 52 orange	26	385	370 x 645 x 308	8.3	40

Accessories:

Lid without cooling plate → for TP 100 KB and TP 100 K

Cooling pellet GN 1/1 plastic

Heating pellet stainless steel GN 1/2: 323 x 263 x 12.5 mm, asymmetrical

Heating pellet stainless steel GN 1/1: 324 x 529 x 12,5 mm, asymmetrical
→ for TP 100 K hybrid

Sealing plug → for TP 100 KB and TP 100 K

Isosteg → for TP 100 hybrid

The use of an Isosteg enables division into hot and cold areas.

Sealing plug → for TP 100 K and TP 500 K

Horizontal frame (without spring) → for TP 100 K and TP 50 K

Order no.

85 02 25 56 orange

85 02 25 57 black

85 02 20 38 orange

85 02 20 67 black

89 08 01 71

89 08 01 72

85 02 20 59 orange

85 02 20 42 orange



37 13 08 41

84 19 02 02



*Further information: See Rieber price guide,
www.rieber.de
Search: Price guide*



Lid without cooling plate



Plastic cooling pellet



Stainless steel heating pellet



Sealing plug (for sealing the TP when rod heating is disassembled)





Horizontal frame for TP 100/50 K (for dividing heated wells, so that smaller containers, e.g. GN 1/4, can be used).

5.2.15 TP 50 KB heated and TP 50 K, (plastic)



TP 50 KB heated
 – Rod heating, statically heated, dry and wet
 TP 50 K

Support rails: —
 Configuration example: 1 x GN 1/1 100 mm

Designation Order no.	Load capacity, max. [litres]	Heating capacity [W]	Outer dimensions L x W x H [mm]		
TP 50 KB heated without CHECK: 85 02 02 06 orange 85 02 02 17 black with CHECK: 85 02 02 24 orange 85 02 02 25 black	11.7	240	370 x 645 x 240	7.3	40
TP 50 K without CHECK: 85 02 02 01 orange 85 02 02 16 black with CHECK: 85 02 02 22 orange 85 02 02 23 black	11.7	—	370 x 645 x 240	6.9	40

Accessories:

 See accessories on previous page

5.3 Information on accessories

5.3.1 Transport safety

User tip

- When transporting the Rieber stainless steel thermoport® use the transport safety device from Rieber.
Highly recommended for transport by HGV.
- How to stack TPs. Large recessed grips facilitate handling.

Example

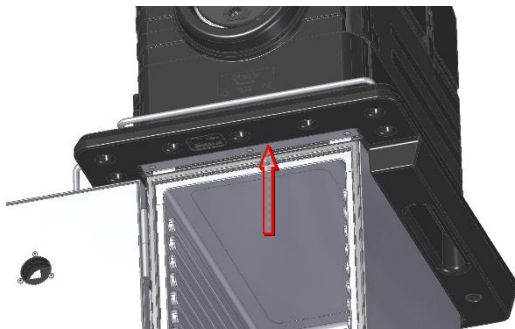

Fixing by means of profile in the door groove

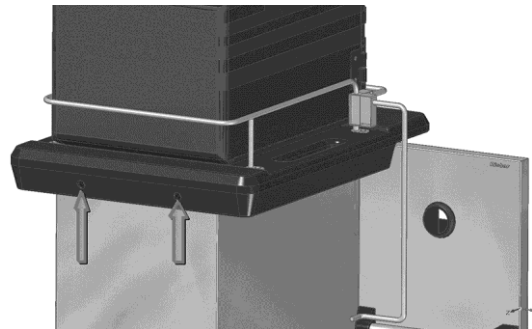

Additional fixing with 2x pressure screws possible, for example for transport by HGV.

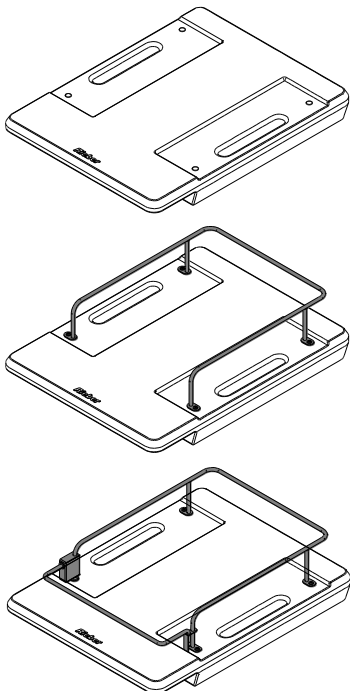

Version: Standard

Suitable for the stainless steel thermoport® from Rieber.
L x W x H: 769 x 592 x 90 mm
Order no.: 85012053

Version: ...with guard rail

L x W x H: 769 x 592 x 90 + 107 mm
Order no. 85012053 + 85100203 /Only available in conjunction with "standard" version, guard rail not available separately.

Version: ...with guard rail & fastening clip

Order no. 85012053 + 85100202

5.3.2 Transport/serving trolley

MOBILE APPLIANCES” ...little helpers

Transport/serving trolley in plastic and stainless steel



PW-TH-RP /Rolloport,
→ for all portable **thermoport**®; with retractable push handle made of stainless steel





TH-TA-1
→ for 1 **thermoport**®



TH-TA-2
→ for 2 **thermoport**®



TH-TA-3
→ for 3 **thermoport**®

Designation Order no.	Outer dimensions L x W x H [mm]	Weight	
			
PW-TH-RP 88 07 06 01	850 x 470 x 890	9	100
TH-TA-1 88 15 01 01	711 x 705 x 840	14	80
TH-TA-2 88 15 02 01	1246 x 705 x 840	21	130
TH-TA-3 88 15 03 01	1781 x 705 x 840	27	210

Antistatic wheels, 4 pcs, diameter 125 mm. on request



Further information: See Rieber price guide, “TRANSPORT” chapter
“www.riever.de
Search: Price guide

Chassis KS





88 14 01 06



88 14 01 05

Chassis KS
Stainless steel with plastic corner bumpers, 2 swivel castors and 2 fixed castors in plastic, diameter 125 mm
→ for TP 1000

Designation Order no.	Outer dimensions L x W x H [mm]		
Chassis KS 88 14 01 05 → Designed to be assembled with TP. Loosen the stack slide rails for this purpose. → Insert 2 space strips into the mouldings in the plastic TP. Order no. 55 01 69 01 → Connect the chassis to the TP with the screws.	640 x 490 x 210	6.2	85
Chassis KS 88 14 01 06 → Place TP on the chassis	640 x 490 x 210	4.7	85

5.3.3 gastronorm360 OPERATING SYSTEM



User tip

With the right accessories, **thermoport**® is energy-saving, and the appliance can be used for a wider range of applications.

- Use GN containers with watertight lids from Rieber.
- Use **thermoplates**® with watertight lids from Rieber.
- Use Rieber **heating pellets** to keep food warm.
- Use Rieber **cooling pellets** to keep food cold.



Further information: See Rieber price guide, chapter "gastronorm360 operating system"



www.riever.de
Search: Price guide

5.3.4 The mobile catering® kitchen



catering® kitchen
On request



Examples

5.3.5 CHECK HACCP

For managing HACCP documentation, the CHECK CLOUD platform offers the CHECK HACCP digital system, for simple, safe and transparent temperature detection. Additional digital features are also possible in the area of hygiene and service management. The automated digital answer to the analogue paper trail.

The HACCP-relevant data are recorded using two different methods:
Mobile CHECK and Auto CHECK. The browser-based CHECK Cockpit enables the management, visualisation and evaluation of the collected process data.

- Mobile CHECK: Manual temperature measurement by means of Bluetooth capable core temperature sensor and CHECK app. Simple hygiene and service management with flexible, individually adaptable checklists and additional photo and text function via the CHECK app.
- Auto CHECK: Retrofittable or permanently installed sensors, which send data to the database at predefined intervals.



*Further information: See "Services" under
www.riever.de
Contact Rieber customer service.*

5.3.6 Excerpt from the Rieber price guide

- Rieber Normset Gastronorm container range
- Rieber lid range for GN containers
- Trays, grilles, stacking shelves
- Supports
- Shelves, EC Gastronorm containers
- Rieber thermoplates® range with angular corners (from -20°C to +220°C)
- Rieber thermoplates® accessories (for thermoplates® with angular corners)
- Rieber thermoplates® C Buffet range – with rounded corners
- ... Lid range accessories
- Kitchenware containers, kitchenware lid range, Rieber kitchenware sets

The Rieber price guide provides further information about a wide variety of accessories.

www.riever.de

Search: Price guide

6 Useful Information on Delivery and Initial Cleaning

This chapter describes the measures to be taken before use.

Appliances with refrigerant R290 are considered hazardous materials and should be handled in accordance with DIN EN 378-1:2020-12!

Check/handle transport damage

- Immediately after delivery, visually check the appliance for any transport damage.
- Document any potential transport damage on the consignment note in the presence of the haulage contractor, and have the damage confirmed by the haulage contractor (with signature).
- Decide if you wish to keep the appliance and report the defect using the consignment note, or if you wish to reject the appliance.

■ By following this procedure you will ensure proper claim settlement.

Unpack

- Open the transport packaging at the positions provided for this purpose. Do not tear or cut.
- Remove any packaging remnants.

Unload appliance



Transport with high physical demands should be avoided where possible, as the risk of an accident or injury is higher.

Lift / deposit a heavy load evenly with your knees bent and your upper body straight and upright. Your feet should be at least hip-width apart and your abdominal muscles braced. Breathe out. Do not twist your spine.



CAUTION

- Transport the appliance horizontally, as in its working position.
- Do not use aids such as forklift trucks to unload and transport the appliance, as this may cause damage.

First cleaning



CAUTION

Protective foils or heat-sensitive objects on/in the appliance might damage the appliance during heating.

- Ensure that there are no protective foils on the inside or outside of the appliance.



'Cleaning, Maintenance and Care', page 59

Information about packaging material

- Dispose of the disposable packaging with respect for the environment.

7 Notes on Use

7.1 Safety information with regard to use

Comply with the operational principles

- Only transport food and liquids closed. Protect thermoport® electrical appliances against moisture, otherwise liquid could penetrate the circulating air heater or the refrigeration unit, for example. We recommend: Use containers with watertight press-in lids such as thermoplates® and Gastronorm containers from Rieber.
- Use TP under supervision.
- Only operate the TP with adequate lighting.
- Warm food: Place in GN containers at +85 °C; the temperature of the food should not fall below +65 °C. Consume the food no later than three hours after preparation, to minimise the risk of food poisoning.
- Cold food: Cold holding between +2 °C and +8 °C.
Cold holding means: Keeping pre-chilled food at storage temperature.
Place in GN containers as cold as possible; the temperature of the food should not exceed +7°C.





Chapter 'Designated Use', page 17 ff.



Chapter 'Insulating behaviour of thermoport®', page 22 ff.

Minimise risks from electricity

Risks when transporting open liquids and food, which could penetrate the circulating air heater of the heated TP or the circulation fan of the actively cooled TP.

-  **Danger of electric shock. Danger of death**
Before cleaning always disconnect the TP from the power, then dismantle the removable heating unit or removable refrigeration unit. **Wipe electrical parts with a slightly damp cloth** and use a **dry cloth to rub dry**.
-  **Danger of electric shock. Danger of death**
Keep the TP 1000 K cool away from moisture. Only use inside buildings.
- Only transport food and liquids in tightly sealed containers.
- We recommend: Use GN containers with watertight press-in lids from Rieber and thermoplates®.



Chapter 'Information on accessories', page 43 ff.,
section **gastronorm360 OPERATING SYSTEM**

- Inspect the appliance before use, particularly the connecting plug and electric cable for any visible signs of damage.

**WARNING**

If the residual current operated device is not series-connected or is defective, cable fire and personal injuries may result.

Peak currents occur if lots of devices are switched on and off simultaneously.

- Connect the TP to a socket with a series-connected residual current operated device (RCD) with a tripping current of 30 mA.
- Do not connect the appliance to a distributor strip.

Minimise risks due to unstable position

- **Load** the appliance from bottom to top.
Unload the appliance from top to bottom.
In this way you will ensure optimal safety against overturning.
- Ensure stable positioning of the TP.
Example of TP 1000 KB: For one appliance, place this far enough back from the installation edge so that when it is emptied the door can rest on the installation surface.

Minimise risks during transport

- Transport TP with closed door/lid and mains plug disconnected.
- Use the Rieber transport equipment range.

 Chapter 'Information on accessories', page 43

Risks from burning and scalding

-  **Risks of scalds to face and hands.**

Allow the hot steam to escape if necessary, before opening the heated TP. Do this by opening the steam valve, for example. Open the lid/door carefully.

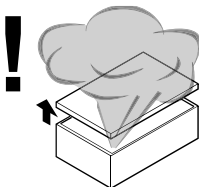
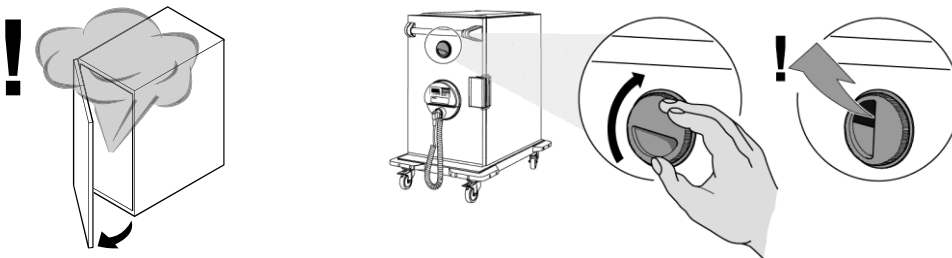

- Wear personal protective equipment and protective gloves in order to avoid burns to the hands and arms.

Installation and removal of the heating unit

 Chapter 'Heated TP', page 64

⚠ What should you do if the circulating air heater is soiled?

 Chapter 'Personnel qualification requirements', page 10

 Chapter 'Heated TP', page 64

7.2 Preheating/precooling the thermoport®

TP can be heated/cooled as required in a heating cabinet or cold store

- Heat or cool the TP in the heating cabinet or cold store, in the range between **+2 °C** and **+85 °C**. Do not cool or store at lower temperatures, as this could result in dangerous electrical leakage currents due to condensation. Only use in dry areas and ambient conditions.

i User tip

- Use the options for keeping warm with heating pellets and for keeping cold with cooling pellets. Use accessories from Rieber.

 Chapter 'Information on accessories', page 43

Electrically heat/cool TP

i User tip

The operating temperature of the empty appliance is reached after a preheating or precooling time of **around 20 minutes** under normal ambient conditions.

- Limit yourself to the necessary heating/cooling time. More time would only waste unnecessary energy.

Some TPs can be used as a bain-marie

→ Applies to: TP 105 L, TP 100 KB-CNS ... with surface heating

→ Applies to: TP 100 KB, TP 50 KB ... with rod heating

Bain-marie

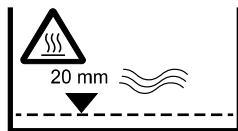

The following is indicated on the top of the container:
 → Hot surface
 → For 'wet heating' pour 2 cm of water into the bain-marie

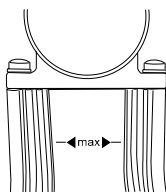

The following is indicated on the heater element:
 → Maximum water level
 → Hot surface
 → Protection class IPX3. Protection against falling spray water up to 60° from vertical
 → Observe the operating instructions
 TP 50 KB or TP 100 KB heated

- Pour water in. A level of around 2 cm is sufficient.
- Preheat for around 20 minutes.
- Use GN containers with press-in lids from Rieber.

7.3 Temperature regulation for circulating air heating

7.3.1 ... with bayonet fitting

Circulating air heater for **stainless steel TP**.

Heating temperature can be regulated between +20 °C and +100 °C

Example

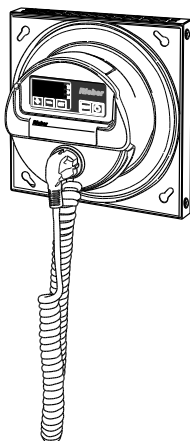

→ Applies to: TP 3000 U, TP 2000 U, TP 3000 hybrid, TP 1600 DU, TP 1600 U, TP 1400 U, TP 1000 DU, TP 1000 H

Circulating air heater for **plastic TP**.

Heating temperature can be regulated between +20 °C and +85 °C

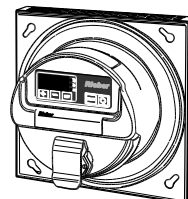

→ Applies to: TP 4.0 1000 KB circulating air

Brief description

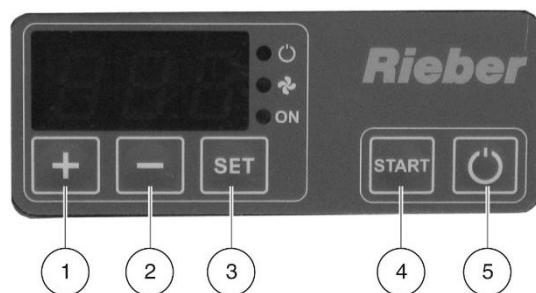

- For electrically-switched devices, the ACTUAL temperature is shown on the control panel.
- The set temperature can be permanently stored. The set temperature can be temporarily changed.

Electrically connect the appliance

- Plug in the electrical connector.

Switch the appliance on

- Turn the appliance on by pressing the POWER ON (5) button.
 - The display shows the ACTUAL temperature.
- Press the SET button (3) to display the SET temperature.

Adjust set temperature

- To change the target temperature, keep the SET button pressed and use buttons (1) and (2) to edit the value.
- Press the START button (4).
 - The set value is saved.
 - This value remains stored after a power failure.

Temporarily change set temperature

- To change the target temperature, keep the SET button pressed and use buttons (1) and (2) to edit the value.
 - This value does not remain stored after a power failure.

Switch the appliance off

- Turn the appliance off by pressing the POWER ON button (5).
 - Empty display, no LED will light up.
 - The appliance is not disconnected from the power.
- Alternatively, disconnect the appliance from the power.

Disconnect the appliance from the power

- Pull out the electrical connector from the socket. If the appliance has a holder to take the electrical connector (dummy connector), insert the connector into this holder.
 - The appliance is de-energised.

7.3.2 ... with click fitting

Circulating air heater for plastic TP.

There are no setting options.

Heating temperature up to +85 °C

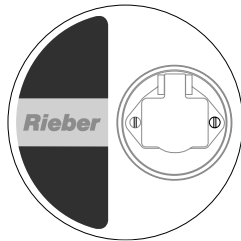

→ Applies to: TP 6000 KB,
TP 1000 KB-A, TP 600 KB-A

Circulating air heater for plastic TP.

Heating temperature can be regulated between +20 °C and +85 °C.

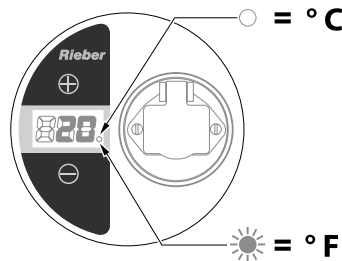

→ Applies to: TP 6000 KB,
TP 1000 KB-D, TP 600 KB-D

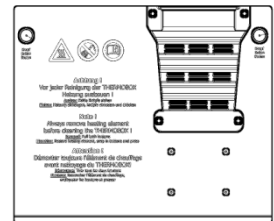

Switch ON/OFF

- The circulating air heater starts to heat when it is connected to the power supply.
 - The temperature inside an empty thermoport® can reach around +80 °C after around 40 minutes under normal ambient conditions.

Temperature display

- The temperature shown on the display is the actual value.
- The displayed value can be between +20 and +85 °C.
At a temperature outside of this range, a fault is displayed → **Cdc**.

Set temperature

- If you wish to change the SET temperature, tap the button.
 - During setting, 3 points are lit at the bottom edge of the display.
 - The target temperature can be changed with a click.
If no button is pressed for 3 seconds, the heating reverts back to normal mode (point stops flashing). The newly set temperature is applied as the target temperature.
- If a target temperature is set below +20 °C, then the OFF symbol is shown in the display.
 - In this mode, only the fan is operated to circulate the air inside. The heating is off.

Display in degrees Celsius °C or Fahrenheit F

- By pressing both buttons at the same time for about 3 seconds, you can change the display of the temperature unit.
 - LED is permanently lit = display in Fahrenheit °F
 - LED is not lit = display in degrees Celsius °C

7.4 Temperature controller for TP actively cooled, (stainless steel)

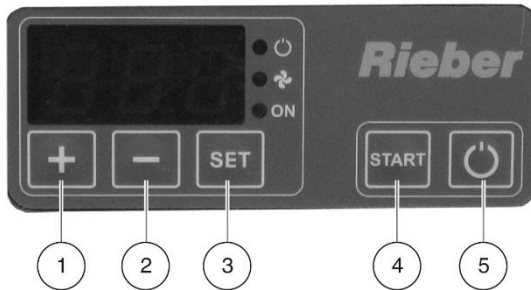

- For electrically-switched devices, the ACTUAL temperature is shown on the control panel.
- The set temperature can be permanently stored. The set temperature can be temporarily changed.
- For appliances for keeping food cold, the LED in the top right indicates whether the compressor is running.

Switch the appliance on

- Turn the appliance on by pressing the POWER ON (5) button.
 - The display shows the ACTUAL temperature.
- Press the SET button (3) to display the SET temperature.

Adjust set temperature

The set temperature can be adjusted from +1 to +15 °C.

- To change the target temperature, keep the SET button pressed and use buttons (1) and (2) to edit the value.
- Press the START button (4).
 - The set value is saved.
 - This value remains stored after a power failure.

Temporarily change set temperature

- To change the target temperature, keep the SET button pressed and use buttons (1) and (2) to edit the value.
 - This value does not remain stored after a power failure.

Switch the appliance off

- Turn the appliance off by pressing the POWER ON button (5).
 - Empty display, no LED will light up.
 - The appliance is not disconnected from the power.
- Alternatively, disconnect the appliance from the power.

Disconnect the appliance from the power

- Pull out the electrical connector from the socket. If the appliance has a holder to take the electrical connector (dummy connector), insert the connector into this holder.
 - The appliance is de-energised.

7.5 Active cold holding

TP for keeping chilled food and beverages cold. Cold holding between +2°C and +8°C. Keeping pre-chilled food at storage temperature.

Control



See page 54

- Only fill the TP with adequately pre-chilled, packaged/wrapped food.
- Leave free space in the appliance. Due to the air convection and the filling level of the appliance, the ACTUAL temperature may deviate from the control temperature.
- Open the door/lid for filling or removal for as short a time as possible.
- Move and chill the food correctly daily after use, switch off and clean the TP.

7.6 Some TPs can be used as bain-maries

→ Applies to: TP 105 L, TP 100 KB-CNS ... with surface heating

→ Applies to: TP 100 KB, TP 50 KB ... with rod heating



See chapter 'Preheating/precooling the thermoport®', page 50

- **⚠ Risk of scalding**
Allow the hot bain-marie to cool down before topping up with water. Open the lid carefully and allow steam to escape at the side.

7.7 Filling containers with food

Note on warm food:

- Place in GN containers at +85 °C; the temperature of the food should not fall below +65 °C.

Note on cold food:

Cold holding between +2 °C and +8 °C

Cold holding means: Keeping pre-chilled food at storage temperature.

- Place in GN containers as cold as possible; the temperature of the food should not exceed +7°C.

Always transport food closed or covered

- Only transport food and liquids in tightly sealed containers.



User tip

Use GN containers from Rieber.

- Seal GN containers containing liquid food using a water-tight plug lid with all-round silicone seal.
- Fill GN container up to the edge of the stacking shoulder.
Do not fill up to the top edge to avoid the lid resting on the meal or in the sauce.

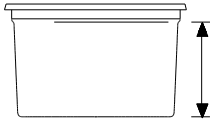

- Immediately after filling the appliance close it and do not open again until just before serving.
- After removal, close the door/lid immediately.

7.8 TP transport

- **⚠ Risk of scalding**
Hot liquids could slop out. Transport horizontally. Use GN containers with watertight press-in lids from Rieber. Close door/lid.
- **⚠ Risk of tipping when stacking**
Make sure that the stacking runners of the upper TP are located in the guides of the lower TP. Only stack with closed lid/door.
- We recommend only stacking 2 TPs on top of each other.
- Only transport the TP with the mains plug disconnected.
- Hold it at the fold-out carrying handles (1), not at the fastening clip (2) of the lid. Only carry 1 appliance at a time, unstacked.

Example

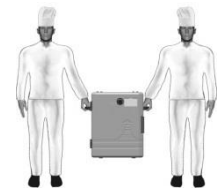
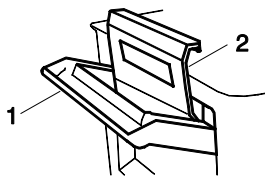

- User tip: Use the Rieber transport equipment range.

Chapter 'Information on accessories', page 43

7.9 Clean the TP daily after use

- Disconnect appliance from the power.
- Clean the appliance daily after use.



'Cleaning, Maintenance and Care', page 59 ff.

7.10 Stacking /storage of TPs

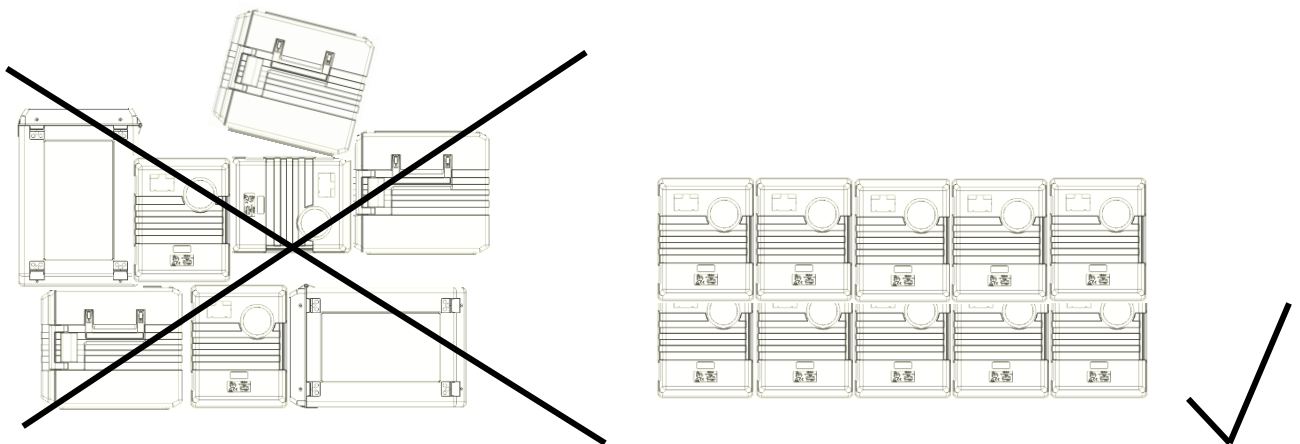

⚠ Risk of tipping when stacking

- Only stack with closed lid. Make sure that the stacking runners of the upper food transport container are located in the guides of the lower food transport container.
- Only stack matching TPs. The plastic and stainless steel versions of the **Rieber thermoport®** can be combined together for stacking.

- Store the empty food transport containers in a clean, dry area.

➤ **ATTENTION**

Store appliance at room temperature.

Please remember: In all areas of the electrical installation condensation may form on highly sealed housings which are exposed to temperature changes and therefore differences in air pressure between the inside and outside, despite high IP protection classes.

Consequently there is a risk of corrosion, electrical short-circuits and other damage. These often lead to power failures, supply bottlenecks and cost-intensive production downtimes.

7.11 Note on permissible changes /modifications

The front door is exchangeable

The door can be easily exchanged.

Example



TP 1600 DU heated



TP 1600 U



TP 1600

Would you like to retrofit CHECK HACCP?

CHECK HACCP can be retrofitted at any time.

- Please contact Rieber customer service.

Would you like a different circulating air heater?

The 'self-regulating circulating air heater' and 'adjustable circulating air heater' are exchangeable.



Page 21

Would you like to equip the TP 6000, TP 1000 with rustproof castors?



Mobile lower frame is bolted onto the underside of the TP, permanently mounted

TP 6000 KB
TP 6000 K

Order no.: 88 14 01 04



TP 1000 KB
TP 1000 K

Order no.: 88 14 01 05



See 'Information on accessories', page 43

8 Cleaning, Maintenance and Care

This chapter will help you to meet the hygiene requirements. Before reading this section, please read through the "General safety instructions" chapter thoroughly first.

8.1 Safety information relating to cleaning, maintenance and care

Avoid risks from electricity



Danger of electric shock. Danger of death.

- Always disconnect the mains connection before cleaning, by removing the connector plug from the main power supply.
- Before cleaning the **heated TP**, remove the removable heating unit.
- Before cleaning the **actively cooled TP**, remove the circulation fan.
- Do not use a steam cleaning unit to clean electrical parts such as heating unit, circulation fan, ON/OFF switch etc.. Doing so may allow moisture to get into the electrical system and cause a short circuit. Do not expose to spray water. **Wipe electrical parts with a damp cloth and rub dry with a dry cloth.**
- Have electrical equipment inspected ³ by a **qualified electrician** in accordance with DGUV. Define the inspection cycle according to the conditions of use. Generally this is every 12 months.

Risk of burns, scalds and slipping



Risk of burns

Risk of burns to hands and arms on the hot heating unit, which can be up to 100 °C, and hot parts inside the TP .



Risk of scalds, for example when emptying hot water from the TP.

→ Relates to TP 105 L, TP 100 KB, TP 100 KB-CNS, TP 50 KB

- Allow the appliance to cool down.
- Drain hot water through a floor drain.
- Wear personal protective equipment, i.e. protective gloves and safety shoes.

➤ **Slipping hazard. Risk of falling**

Watch out for condensation water running off the 'actively cooled TP'.

➤ **Maintenance of refrigeration units with refrigerant R290**

Refrigeration units with refrigerant R290 may only be repaired and maintained by specialist companies authorised by the manufacturer or by the Rieber company.

³ Source: DGUV Regulation 3. Electrical systems and equipment

8.2 Cleaning agents for stainless steel

The following applies for all cleaning agents:

- Observe the instructions for use provided by the cleaning agent manufacturer.

Mechanical cleaners for stainless steel

Cleaning agent	Suitable
Brush products	Brushes with natural or synthetic bristles
Textiles	Textile material comprising natural and chemical cleaning fibres and textile fabrics (knitted and woven fabric, cleaning cloths, floor cloth, fringed material, fleece). Microfibre cleaning textiles are ideal for removing finger marks from stainless steel surfaces.
Synthetic fleece	Without abrasives. Mainly produced in the colours white, beige, yellow.
Other	Natural leather (chamois), synthetic leather, synthetic fleece, sponges, sponge cloths

Chemical cleaners for stainless steel

Cleaning agent	Areas of application
All-purpose cleaners	Particularly for lighter grease stains.
Neutral cleaners	For surfaces soiled with grease and oil (fingerprints); also suitable as dishwasher detergent.
Alcohol cleaners	As all-purpose cleaner
Alkaline cleaners	Especially for heavy grease and oil stains (dried-in oils). Observe the manufacturer's dosage instructions.
Solvent cleaners	Depending on the type, particularly good for the removal of grease, oil, wax, tar, adhesives, paints and lacquers. Not suitable for plastics.
Disinfectant cleaners	Effect on pathogenic germs differs depending on active disinfectant ingredient. Long-term exposure to sodium hypochlorite can cause damage to the material. It should not be used if possible. Products that are specified in the list of the German Society of Hygiene and Microbiology (DHGM) should be used.

8.3 Choose the correct cleaning method



CAUTION

Incorrect cleaning can damage the surface or even destroy the appliance. Please note:

- Do not scratch the surface with sharp-edged objects. Do not use any abrasive or aggressive cleaning agents, such as oven spray or a sponge with an abrasive surface.
- Remove dirt with cleaning and care products that are suitable for stainless steel.
- Do not mix commercially available cleaning agents; do not make your own cleaning agent.
- Do not use steel wool or steel brushes.
- Avoid extended exposure of stainless steel to liquid containing salt, as this can lead to surface discolouration or corrosion.
- Avoid direct, extended contact of stainless steel with corroding iron parts, e.g. cast iron pans or steel kitchen sponges.

Clean and service stainless steel parts

→ Applies to the stainless steel housing of the TP



CAUTION

Incorrect cleaning can cause damage to the surface.

- Do not clean stainless steel TP housing in the dishwasher.
 - Clean with a **hot, mild liquid detergent solution**, wiping with a **damp, scratch-free cloth**. Then remove the cleaning residues with a well rinsed-out cloth.
- After cleaning, rub surfaces dry with a soft cloth. The cloth should be well rinsed out beforehand.



User tip

- We recommend **Rieber cleaning agent for cleaning stainless steel**.
 - It is an especially thorough yet gentle cleaner, produces a dazzling shine, and cleans and protects in one.
 - Order no.: 72 10 24 08

Cleaning and care of plastic TP and plastic parts

→ Relates to the housing of the plastic TP, the castors, operator's controls such as switches and control unit, door seal



CAUTION

Incorrect cleaning can cause damage to the surface.

- Avoid using a high-pressure cleaner if the operating temperature exceeds +130 °C. Keep an adequate distance.
 - Clean the housing with a **hot, mild liquid detergent solution**, wiping it with a **damp, scratch-free cloth**. Then remove the cleaning residues with a well rinsed-out cloth.
- After cleaning, rub surfaces dry with a soft cloth. The cloth should be well rinsed out beforehand.



User tip

- For cleaning a plastic TP in the dishwasher, we recommend cleaning agent ETOLIT 3000 and 8000.

Clean seal of door/lid

→ Applies to: Stainless steel TP



CAUTION

Incorrect cleaning can damage the seal of the door/lid.

- Do not clean with a high-pressure cleaner. Do not clean in the dishwasher.
 - Clean with a **hot, mild liquid detergent solution**, wiping with a **damp, scratch-free cloth**. Then remove the cleaning residues with a well rinsed-out cloth.
- After cleaning, rub surfaces dry with a soft cloth. The cloth should be well rinsed out beforehand.
- Remove the seal for cleaning if necessary.

Clean castors









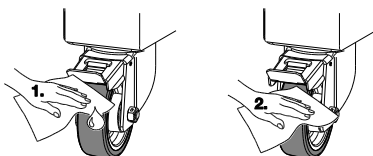





CAUTION

Cleaning the castors incorrectly can damage them.

- Do not clean with a high-pressure cleaner.
- Clean with a **hot, mild liquid detergent solution**, wiping with a **damp, scratch-free cloth**. Then remove the cleaning residues with a well rinsed-out cloth.



8.4 Overview of intervals

Interval	Activity to be performed	Page
Daily after use	Unplug the mains plug. Open the door/lid.	
	Allow the TP with heating to cool down.	
	 Watch out for condensation running off the TP for keeping food cold. Slipping hazard.	
	 Check the appliance and connection cable for any damage. A damaged mains cable must be replaced by a qualified electrician.	
	Choose the correct cleaning method	 <i>Page 60 ff.</i>
	Remove the removable heating unit from the heated TP. Reinstall the heating unit after cleaning.	 <i>Page 64</i>
	Remove the circulation fan on the actively cooled TP (made of stainless steel). Reinstall the circulation fan after cleaning.	 <i>Page 66</i>
If required	Clean the carcass of the TP	 <i>Page 61</i>
	Clean the seal → Applies to stainless steel TP	 <i>Page 67</i>
	Clean castors	 <i>Page 61</i>
	Remove fluff, clean ventilation grille.	 <i>Page 66</i>
	At least 1x monthly.	 <i>Page 67</i>
Every 180 working days or 6 months	Have electrical system /control checked	 <i>Page 59</i>
	Inspect condition of product identification	 <i>Page 15</i>

8.5 Heated TP

8.5.1 Disassembly and installation of the heating unit

- **⚠ Danger of electric shock. Danger of death**
Remove the removable heating unit before cleaning the heated TP. **Wipe electrical parts with a slightly damp cloth** and use a dry cloth to rub dry.
- **⚠ Risk of burns**
Wear personal protective equipment and protective gloves to prevent burns on the hot heating unit, which can be up to 100 °C.

Circulating air heater with bayonet fitting

The circulating air heaters with bayonet fitting are unmistakable thanks to the arrangement of the keyholes.

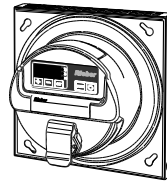
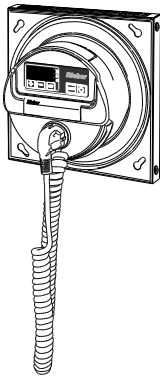

In the stainless steel version of the **thermoport®** the electrical connection cable is stored in the dummy connector.

In the plastic version of the **thermoport®** the electrical connection cable is connected separately.

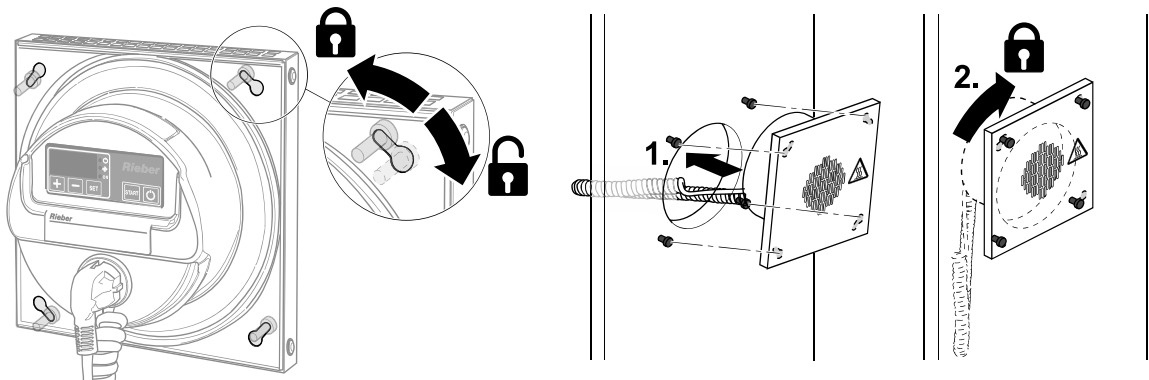

- **Disassembly:** Open the door. Rotate the heating unit by around 10 degrees from the inside of the door and remove it.
- **Installation:** Open the door. Push the connection cable through from the inside of the door. Install the heating unit.

Circulating air heater with click fitting

→ Applies to TP 6000 KB, TP 1000 KB, TP 600 KB

Thanks to the spring-actuated click lock, the heating can be installed/uninstalled easily.

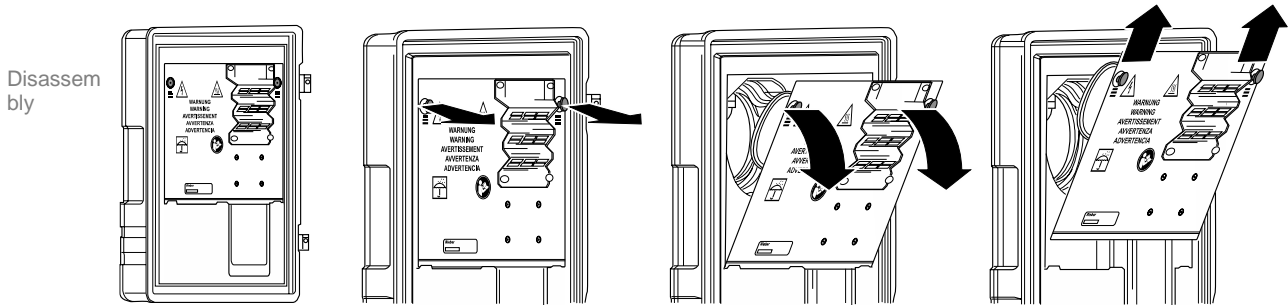

- Pull on the click fitting to loosen the connection, tilt the heating unit and remove it.

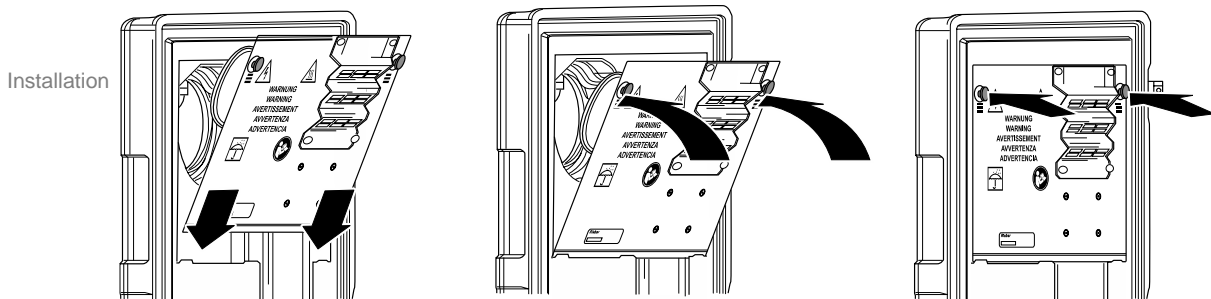

- Place the heating unit in the mounting recess. Swivel the heating unit into the recess in the door and press, until the fixing buttons audibly engage.

Rod heating

→ Applies to TP 100 KB heated, TP 50 KB heated



CAUTION

The heating rod and the seal on the container can be damaged by incorrect handling.

- Remove and reinstall the heating rod step by step using light rotary movements, do not lever.

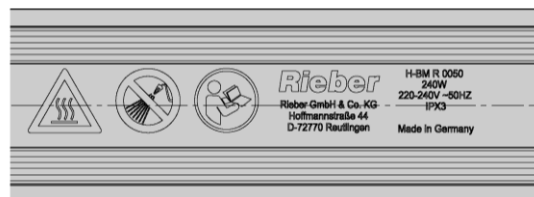
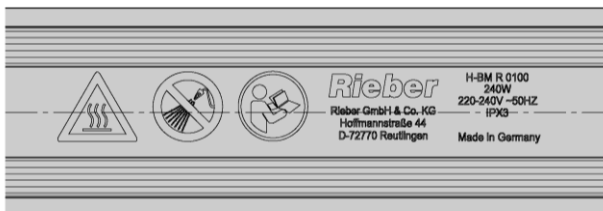
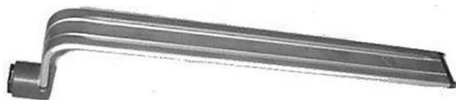

8.5.2 Keep the heating unit clean

→ Applies to: Heated TP with circulating air heater, heated TP with rod heater

- **⚠ WARNING**
Wipe the heating unit with a **slightly damp cloth** and **rub dry with a dry non-scratch cloth**.
- Remove aspirated dust from the fan of the circulating air heater using compressed air. Do not poke anything into the ventilation grille.
- **⚠ WARNING**
Do not open the circulating air heater.



See 'Personnel qualification requirements', page 10

8.6 Actively cooled TP, (stainless steel)

8.6.1 Disassembly and installation of the circulation fan

→ Applies to actively cooled TP, TP hybrid actively cooled

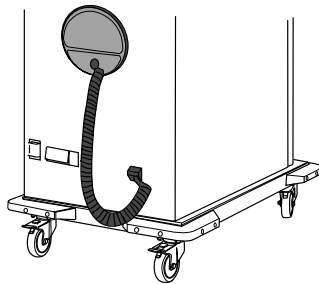

- **⚠ WARNING**
Danger of electric shock. Risk of injury due to rotating fan wheel.
Before cleaning the actively cooled TP, disconnect the appliance from the power and remove the circulation fan. Wipe electrical parts **with a slightly damp cloth** and use a dry **cloth to rub dry**.
- **Disassembly:** Open the door. Rotate the cooling air fan by around 10 degrees from the inside of the door and remove it. Loosen the position with the slider.
- **Installation:** Open the door. Push the connection cable through from the inside of the door. Install the cooling air fan. Make sure that it is mounted in all 4 bolts. Secure the position with the slider.

8.6.2 Keep the ventilation grille clean



⚠ Risk of fire

Fluff in the ventilation area can cause a build-up of heat which could result in a fire.

- Clean the ventilation grille on the refrigeration machine compartment using a cloth, paintbrush or vacuum cleaner.
- Adapt the cleaning cycle to the local requirements. Clean at least once a month.

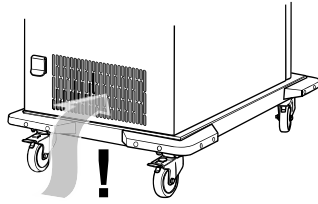

Air outlet

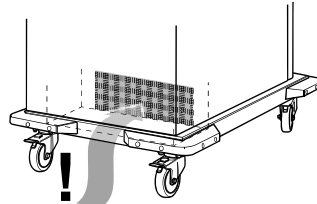

Suction opening

8.7 Information on cleaning

⚠ Prerequisite

- TP de-energised. Mains plug unplugged
- Circulating air heater, rod heater removed
- Circulation fan of 'actively cooled TP' removed
- Do not clean the TP with a high-pressure jet or in the dishwasher.

Procedure

- Make sure that the cover on the socket is fully closed.

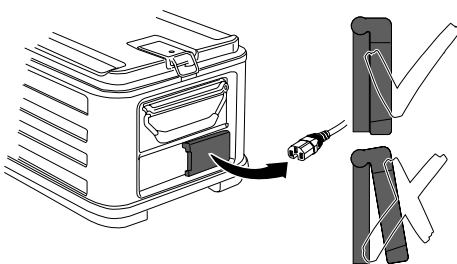

Example of TP 105 L, (made of stainless steel)

➤ ATTENTION

Clean the TP with a **hot, mild washing up detergent solution**, wiping it with a **damp, non-scratch cloth**.

- After cleaning, rub surfaces dry with a soft cloth. The cloth should be well rinsed out beforehand.
- Dry the inside of the appliance and leave the lid open until the residual moisture has dried off.

8.8 Note on storage

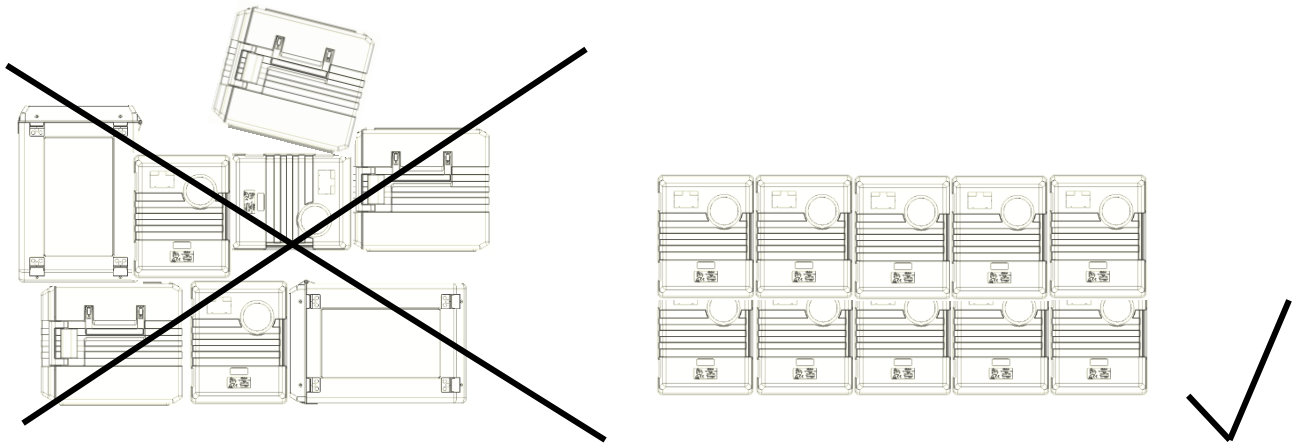

Risk of tipping when stacking

- Only stack with closed lid. Make sure that the stacking runners of the upper food transport container are located in the guides of the lower food transport container.
- Only stack matching TPs. The plastic and stainless steel versions of the **Rieber thermoport®** can be combined together for stacking.

-
- Store the empty food transport containers in a clean, dry area.
 - **ATTENTION**
Store appliance at room temperature.
Please remember: In all areas of the electrical installation condensation may form on highly sealed housings which are exposed to temperature changes and therefore differences in air pressure between the inside and outside, despite high IP protection classes. Consequently there is a risk of corrosion, electrical short-circuits and other damage. These often lead to power failures, supply bottlenecks and cost-intensive production downtimes.

8.9 Keep appliance ready for next use in dry condition

- Dry the inside of the appliance and leave the door / lid open until the residual moisture has dried off.

9 Operating Faults / Service



⚠ Danger of electric shock. Danger of death

- Before carrying out repairs on the appliance, disconnect it from the power. Do this by unplugging the electrical power plug.
- Have all electrical repairs carried out by an authorised electrician.

Any repairs during the warranty period may only be carried out by the Rieber service department. Please contact the Rieber service department.

Only spare parts that have been approved and specified by the manufacturer may be used. Certain repairs may only be carried out by the Rieber service department.

Work on the cooling unit should only be carried out by authorised skilled personnel like a refrigeration specialist or a member of Rieber Customer Service.

Fault	Possible cause	Rectification
Circulating air heater soiled	Food and liquids have not been transported in closed containers. The TP may have fallen.	<ul style="list-style-type: none"> ➤ Repair <ul style="list-style-type: none"> # Rieber Service or authorised partner # Appropriately trained and authorised operating personnel
Heating not working	Heating defective	<ul style="list-style-type: none"> ➤ Repair <ul style="list-style-type: none"> # Rieber Service or authorised partner
Controller not working	Controller defective	<ul style="list-style-type: none"> ➤ Repair <ul style="list-style-type: none"> # Rieber Service or authorised partner
Insufficient cooling	Wrong target temperature setting	<ul style="list-style-type: none"> ➤ Check <ul style="list-style-type: none"> # Operating personnel
	Food not pre-chilled sufficiently	<ul style="list-style-type: none"> ➤ Check <ul style="list-style-type: none"> # Operating personnel
	Not enough refrigerant in appliance	<ul style="list-style-type: none"> ➤ Repair <ul style="list-style-type: none"> # Refrigeration expert
Castor defective	Wear, damage	<ul style="list-style-type: none"> ➤ Replace <ul style="list-style-type: none"> # Mechanical specialist



Page 10

Customer service, spare parts



Visit us on the Internet at <http://www.rieber.de>



IMPORTANT

Customer Service needs information about the type and number of your appliance.

- If you have a fault you cannot remedy yourself, please get in touch with your Rieber partner or Rieber central customer service.

Disposing of your product



Do not dispose of electrical appliances in the household waste!

Your appliance is made of high-quality materials which can be reused / recycled. You can hand over your appliance or send it at your own costs to Rieber, Ernst-Abbe-Straße 9, 72770 Reutlingen for professional recycling.



Risk of suffocation

Persons with limited sensory and mental ability could get locked in.

- When disposing of the appliance, destroy the door lock.

10 Warranty and Liability

Manufacturer liability and warranty shall no longer apply if you

- do not follow the information and instructions in this user guide,
- use the appliance for any purpose other than the intended use,



See chapter "Designated Use"

- carry out conversions or functional modifications,
- use non-original spare parts.

The "Sales and delivery terms and conditions" of Rieber GmbH & Co. KG shall apply for all warranty claims made against the manufacturer. For instance, any repairs and/or overhaul during the warranty period may only be performed by the Rieber service department, failing which any resulting claims may be voided. Please contact the manufacturer Rieber.

NOTE: If the product identification is damaged or illegible, the warranty will be invalidated. Contact Rieber Customer Service as early as possible in the event of damage.

The following wear parts are not included in the warranty:

- Castor, castor with parking brake, corner bumper, stacking lock, stacking runner

11 Manufacturer's address

Rieber GmbH & Co. KG
Hoffmannstraße 44
D 72770 Reutlingen
Phone +49 (0) 7121 518-0
FAX +49 (0) 7121 518-302
Email info@rieber.de
www.rieber.de