



## Banquet Trolley System

- The banquet trolleys for hot meals. → For hot holding, with circulating air
- The banquet trolleys for cold meals. → For cold holding, with circulating air
- For the systems catering industry



Observe the operation instructions  
Translation of the Original user guide

DOWNLOAD: USER MANUAL

QR code on type plate



EN

**Rieber Professional.** Our solutions guarantee high quality, safety and, above all, excellent energy efficiency and cost effectiveness.

## Contents

<b>1</b>	<b>Revision index</b> .....	<b>4</b>
<b>2</b>	<b>Important information</b> .....	<b>4</b>
2.1	Use of this guide .....	4
2.2	Representation conventions in the text.....	5
2.3	Structure of safety instructions .....	5
<b>3</b>	<b>General safety instructions</b> .....	<b>6</b>
3.1	General behaviour .....	6
3.2	On use of electrical appliances.....	6
3.3	Operator's duties.....	7
3.4	Personnel qualification.....	8
3.5	Provide protective equipment for personnel.....	8
3.6	Appliance-specific safety instructions.....	9
3.6.1	Safety and monitoring devices.....	9
3.6.2	Danger of burns by hot surfaces.....	9
3.6.3	Danger of electric shock.....	9
3.6.4	Dangers during transport and by unstable position .....	10
3.6.5	Warnings against use of the appliance by children .....	10
3.6.6	Danger of getting locked in and danger of suffocation .....	10
3.7	Information about regulations to be followed.....	11
3.8	Instructions on behaviour in an emergency.....	11
<b>4</b>	<b>Purpose</b> .....	<b>12</b>
4.1	Generally, the following are intended uses for the product .....	12
4.2	Prevent foreseeable misuse and abuse .....	12
4.3	Special instructions regarding proper use .....	13
4.3.1	Banquet trolley for hot meals with programmable controller .....	13
4.3.2	Banquet trolley for hot meals with manual control.....	13
4.3.3	Banquet trolley for refrigerated meals with programmable controller.....	13
<b>5</b>	<b>Description of appliance</b> .....	<b>14</b>
5.1	Identification.....	14
5.2	Technical Details.....	15
5.3	Accessories.....	16
<b>6</b>	<b>Before first use</b> .....	<b>17</b>
6.1	Transport.....	17
6.1.1	Check/handle any transport damage .....	17
6.1.2	Unpacking .....	17
6.1.3	Dispose of packaging material.....	17
6.1.4	Clean the appliance .....	18
6.2	Commissioning / recommissioning .....	18

<b>7</b>	<b>Use .....</b>	<b>19</b>
7.1	Safety instructions on use.....	19
7.2	Instructions on use.....	20
7.3	Banquet trolley with water container for warm food .....	21
7.4	Banquet trolley without water container for warm food .....	22
7.5	Banquet trolley for refrigerated meals with programmable controller.....	23
<b>8</b>	<b>Cleaning, maintenance and care .....</b>	<b>24</b>
8.1	Safety information relating to cleaning, maintenance and care .....	24
8.1.1	Avoid dangers due to hot parts or areas.....	24
8.1.2	Prevent risks due to electricity .....	24
8.1.3	Choose the correct cleaning method .....	25
8.2	Emptying the water tank .....	25
8.3	Descale the appliance as required .....	26
8.4	Clean and service stainless steel parts .....	26
8.5	Clean and service plastic parts.....	27
8.6	Cleaning the seal .....	27
8.7	Cleaning the casters .....	27
8.8	Cleaning the ventilation grill of the appliance for cold holding .....	27
8.9	Defrosting the appliance for cold holding .....	28
8.10	Have coolant filling level checked.....	28
8.11	Keep ready for next use in dry condition .....	28
<b>9</b>	<b>Faults/Service.....</b>	<b>29</b>
<b>10</b>	<b>Warranty and liability .....</b>	<b>31</b>
<b>11</b>	<b>Excerpt from the EU Declaration of Conformity.....</b>	<b>31</b>
<b>12</b>	<b>Contact address .....</b>	<b>32</b>

## 1 Revision index

Revision	Change
2011-08-18	First issue
2013-03-05	BGV A3 Fußnote, Auszug EG-Konformitätserklärung, Adresse
2013-04-29	Ergänzung Technische Daten
2014-11-14	VDE-Generaländerung, Signalwort gemäß EU-Empfehlung
2016-06-23	Wasserbehälter entfällt; Generaländerung
2020-07-24	Schutzart, Technische Daten

## 2 Important information

### 2.1 Use of this guide

---

This guide contains important information about how you can use the appliance safely and correctly.



- It is essential that you read the user guide before using the product for the first time.
- Keep this guide in a safe place and pass it onto the next owner should you wish to part with the product.

Our customers often express the wish to have one compact guide instead of a number of different guides for these product variants, which have similar functions.

If there are any deficits from your point of view, please do not hesitate to let us know. With your help, we will try to get even better.

Please add your notes here 😊

---

---

---

---

---

---

## 2.2 Representation conventions in the text

---

... **Highlighting** ... , text to be highlighted

- Listings are represented in this way.
- Instructions on certain actions are represented in this way.
  - █ The result of the action is represented in this way.



See '...' cross-references are represented in this way.



### NOTE

indicates potential damage to property without any personal injury. Failure to follow these instructions may cause damage to property.



### User tip

- Useful information or tip

## 2.3 Structure of safety instructions

---

The signal words DANGER - WARNING - CAUTION classify the degree of risk of bodily injury in an actual situation. You can avoid injury by complying with the behavioural rules provided.

The warning triangle symbol indicates a "General Danger".



### DANGER

indicates imminent danger.

Failure to follow these warning instructions will result in **serious bodily injury or even death**.



### WARNING

indicates a **potentially hazardous situation**.

Failure to follow these warning instructions **may cause serious bodily injury or even death**.



### CAUTION

indicates a **potentially harmful situation**.

Failure to follow these warnings **may cause minor bodily injury**.

### 3 General safety instructions

This chapter provides information about residual risks and hazards despite compliance with the intended use of the device. Generally applicable safety instructions that should generally be complied with are listed here. Action- and situation-based safety regulations are presented as well and precede the relevant action or situation.

The information here such as 'Basic rules of conduct', 'Operator's obligations' etc refer only to already legally required compliance requirements such as the workplace regulations according to German law.

#### 3.1 General behaviour

---

This appliance meets the current state of the art and complies with all acknowledged technical safety-related regulations. Nevertheless hazards may still arise.

- Only use this appliance when it is in fault-free condition and according to the instructions in this user guide.
- During all phases of the appliance's life please ensure that the appliance is safely integrated into its environment.
- Do not make any conversions or modifications to the appliance.

#### 3.2 On use of electrical appliances

---

Safety instructions according to EN 60745-1:

##### **Work area**

- Keep your work area clean and tidy. A messy or unlit work area can cause accidents.
- Keep children and other persons at a distance when using the product.

##### **Electrical safety**

- The plug on the unit must fit in the socket. Do not modify the plug in any way. Never use an adapter in combination with earthed appliances. Using an unmodified plug and a suitable socket will reduce the risk of an electric shock.
- Avoid bodily contact with earthed surfaces such as pipes, heating units, cookers and refrigerators. The risk of an electric shock is greater when your body is earthed.
- Keep the appliance away from rain or damp. Allowing water to get into an electric appliance will increase the risk of electric shock.
- Do not misuse the cable by using it to remove the plug from the socket. Always remove whilst holding onto the plug. Keep the cable away from heat, oil, sharp edges or the moving parts of other appliances. Using damaged or tangled cables increases the risk of electric shock.
- When working with an appliance outdoors, only use extension cables which are permitted for outdoor use. Using an extension cable suitable for outdoor use reduces the risk of electric shock.
- Potential risk of fire due to heat build-up. Unwind the cable from the spool to prevent any heat build-up or cable fire. The coupling must have splash protection, must be made of rubber or be rubber-coated.

#### **Safety guidelines for persons**

- Be attentive and pay attention to what you are doing, act rationally when working with an electrical appliance. Do not use the appliance when tired or under the influence of drugs, alcohol or medication.  
Just one moment of inattention whilst using the appliance can result in serious injury.
- Make sure the appliance cannot be switched on unintentionally. Double check that the main switch is in the "OFF" position before inserting the plug in the socket. Connecting the appliance to the power supply while it is switched on can cause an accident.

#### **Careful handling and use of electrical appliances**

- Never use an electrical appliance with a faulty switch. An electrical appliance which can no longer be switched on or off is dangerous and must be repaired.
- Keep unused electrical appliances in places where children are not able to reach them. Do not allow the appliance to be used by persons who are not familiar with it or persons who are not familiar with this user guide. Electrical appliances are dangerous when in the hands of inexperienced persons.
- Handle the appliance carefully. Make sure all moving parts of the appliance work perfectly and are not jammed, also check whether any parts are broken or damaged to the extent that operation of the appliance is impaired. Have any damaged parts repaired before using the appliance. Many accidents are caused by poorly-maintained electrical appliances.
- Use electrical appliances, accessories etc. in accordance with these guidelines and in a manner that is specified for this particular appliance type. When using the appliance, please take into account the working conditions and the work being carried out. Using electrical appliances for other uses than that intended can lead to hazardous situations.

#### **Service**

- Only have the device repaired by qualified and authorised staff. Only use original spare parts. In this way you can ensure that the appliance remains safe.

### **3.3 Operator's duties**

---

#### **Operator**

The operator is the person who operates the appliance for commercial or economic purposes either himself/herself or lets others use it and bears the legal appliance responsibility for protection of the user, staff or any third parties during operation.

#### **Operator's duties**

The appliance is used in commercial applications. For this reason, the operator of the appliance must meet all legal duties relating to work safety.

In addition to the safety instructions in this guide, the safety, accident prevention and environmental protection regulation applying to the application of the appliance must be complied with.

In particular, the following shall apply:

- The operator must be familiar with the applicable work safety regulations and identify, by carrying out a risk analysis, any additional hazards which are due to the place where the appliance is used. These hazards must be addressed in the form of operating instructions governing the operation of the appliance.
- During the whole service life of the appliance, the operator must verify if the operator's operating instructions reflect the current versions of the applicable regulations. If necessary, the operator must update the operating instructions accordingly.
- The operator must define and assign the responsibilities for installation, operation, repair, maintenance and cleaning clearly.

- The operator must make sure that all personnel working with the appliance have read and understood this guide. In addition, the operator must train the personnel and inform them of the hazards involved at regular intervals.
- The operator must provide the personnel with the necessary protective equipment and make sure that they wear it.

In addition, the operator must ensure that the appliance is always in a perfect technical condition. For this reason, the following shall apply:

- The operator must ensure that the maintenance intervals defined in this guide are obeyed.
- The operator must have all safety equipment be checked regularly for completeness and proper function.
- The operator must ensure that the required media connections are available.
- The operator must ensure that all safety-relevant measures required on site are taken.

### 3.4 Personnel qualification

---

Safe operation requires certain technical skills and personal qualification of each person.

- The responsibility for organization lies with the '**Designated Representative**' (operator). According to EN 50110-1, the Designated Representative is a 'person assigned the direct responsibility for the performance of the work. If necessary, this responsibility can be assigned partly to other persons. [...] The designated representative must instruct all persons involved in the work on all hazards which may not be obvious for them'.
- The work may only be performed by '**instructed persons**' who have been trained accordingly. Training, instructions must be repeated, proper understanding must be verified (ideally by way of an appropriate test).
- Only '**Qualified Staff**' is allowed to carry out repair work. IEC 60204-1 defines qualified personnel as "persons who, on account of their training and relevant experience are in the position to recognise risks and avoid potentially dangerous situations."
- Electrical work may only be carried out by trained and experienced **electricians**. Electro-technically instructed persons may only work under the supervision of a qualified electrician.
- Work on the cooling unit should only be carried out by authorised skilled personnel like a **refrigeration specialist**.
- Repairs and/or overhaul during the warranty period may only be carried out by the Rieber service department, otherwise any resulting claims may be void.

### 3.5 Provide protective equipment for personnel

---

- Ensure that the personnel wears the personal protective equipment appropriate to the relevant situation.
- Wear sturdy shoes to avoid injury.
- Wear safety gloves to avoid burns at hands and arms.



## 3.6 Appliance-specific safety instructions

This chapter describes general, appliance-specific safety instructions. In the following section, additional safety information relating to a particular operation or situation is placed before the appropriate operation step or description of the situation.

### 3.6.1 Safety and monitoring devices

- The appliance features a safety cut-out. The appliance switches itself off automatically in the event of a fault to the control system.
- To increase your safety we recommend you install an earth leakage circuit breaker with a tripping current of 30 mA upstream to the appliance.

### 3.6.2 Danger of burns by hot surfaces

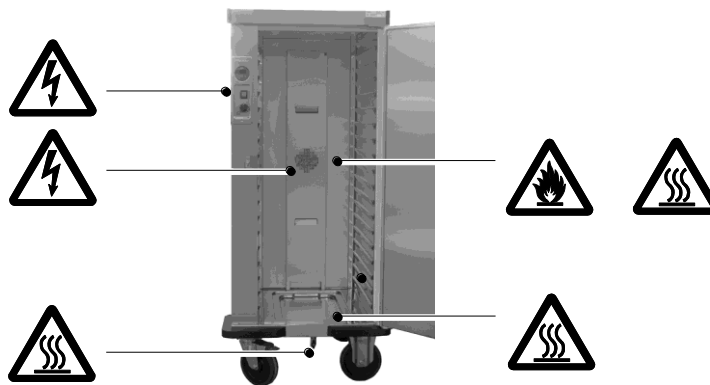

#### **WARNING**

One can burn one's hands and arms on the hot surfaces around the heating and its environment.



- Only use Gastronorm containers made from heat-resistant or non-flammable materials, otherwise there is a risk of fire.
- Wear protective gloves.
- Keep door closed.
- Keep unauthorised persons away from the appliance.
- Keep combustible materials away from the product.

### 3.6.3 Danger of electric shock

#### ➤ **WARNING**

Danger of electric shock. Keep the appliance away from rain or damp. Allowing water to get into an electric appliance will increase the risk of electric shock. A damaged mains cable must be replaced by a qualified electrician.

#### ➤ **WARNING**

Install the electric cable such that risks like falling over or tearing off the cable, etc. are avoided.

### 3.6.4 Dangers during transport and by unstable position

- **⚠ WARNING**  
Danger of electric shock. Before each transport, disconnect the electric power cable.
- **⚠ WARNING**  
Do not pull, only push the appliance. This ensures good visibility and direct access to the casters with brakes.  
Keep the door closed during transport and push the appliance by the handle. Wear sturdy shoes to avoid injuries.
- **⚠ WARNING**  
Prevent unintentional moving of the unit and the resulting hazards. Prevent the appliance from running away accidentally using the two parking brakes. Only park the appliance on flat surfaces.

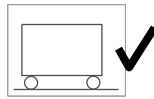
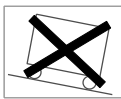

- **NOTE**  
Note the permissible step height, max. 4 mm, otherwise the casters might be damaged.

### 3.6.5 Warnings against use of the appliance by children

- This appliance can be used by children aged 14 and over and by persons with reduced physical, sensory or mental capabilities or lack of experience and/or knowledge, if they are supervised or if they have been instructed in safe use of the appliance and have understood the resulting risks.
- Children must not play with the appliance.
- Cleaning and user maintenance may not be carried out by children without supervision.

### 3.6.6 Danger of getting locked in and danger of suffocation

- **⚠ WARNING**  
Danger of suffocation if persons get locked in the appliance. Protect the appliance from by persons with limited sensory and mental ability.

### 3.7 Information about regulations to be followed

---

Alongside this user guide there are a range of health and safety and other regulations that are relevant for the operation of this cooking station; these include HACCP food hygiene regulations for example.

### 3.8 Instructions on behaviour in an emergency

---

- In an emergency, always disconnect the appliance from power supply.

#### **First aid in the case of burns and scalding or electric shock**

- Inform yourself on this before commissioning the appliance.
- Store the emergency equipment, including the relevant instructions, at a readily accessible place near the place of use. Make yourself familiar with the instructions.



#### **User tip**

- Inform yourself in detail taking the company-internal instructions as a reference.
- We recommend that half-yearly emergency training sessions should be carried out.

## 4 Purpose

This chapter describes the intended use and contains warnings against misuse, for your safety.

### 4.1 Generally, the following are intended uses for the product

---

- For systems catering, general catering, hotels, also for community and school catering.
- For thermally insulated transporting of heated or chilled food.
- For use by instructed adults only.
- Proper use of the appliance also includes compliance with the Technical Details.
- Only use spare parts approved by the manufacturer. Only use spare parts ordered/delivered via the manufacturer's service department.
- Use with plates and cloches on grilles or with Gastronorm containers is recommended.

### 4.2 Prevent foreseeable misuse and abuse

---

- This appliance can be used by children aged 14 and over.



*Also refer to 'Warnings against use of the appliance by children', page 10*

- To prevent persons from injuring themselves on hot surfaces and to prevent tampering with the drainage cock of the moistening water tank, use of the product in public/for self-service should only be allowed under constant supervision.
- Keep any combustible or explosive fluids away from heatable appliances. Otherwise a fire or explosion may arise.
- Never use GN containers made from non thermally-conductive or flammable materials, otherwise there is a risk of fire.
- Do not use to heat up a room.
- Incorrect cleaning can substantially and irreparably damage the stainless steel surfaces.
- Do not pull or push the appliance over sharp edges, danger of material damage.
- Do not use this appliance under poor floor conditions.
  - We are not able to rule out the possibility of marks appearing on the floor due to friction with casters or the formation of scratches due to split cracks in the casters.
  - We are not able to rule out the possibility that the castors may be damaged or become unusable due to swelling or sharp edges on the floor.
- Mobile appliances may only be moved manually. Machine-aided transport, using fork lift trucks or lift trucks, is not permissible.
- Not intended for private use at home.

---

## 4.3 Special instructions regarding proper use

---

### 4.3.1 Banquet trolley for hot meals with programmable controller

- Banquet trolleys for hot meals to be used for holding hot meals hot; not to be used for regenerating.

### 4.3.2 Banquet trolley for hot meals with manual control

- Banquet trolleys for hot meals to be used for holding hot meals hot; not to be used for regenerating.

### 4.3.3 Banquet trolley for refrigerated meals with programmable controller

- Banquet trolleys for cold meals to be used for holding cold meals.
- Banquet trolleys for cold meals to be used for holding cold meals cold; not to be used for cooling down.

#### # Avoid material damage

##### ➤ NOTE

Material damage possible if the unit is not transported properly (e.g. "headlong").  
After transport of electrically refrigerated appliances, allow the coolant to be collected.

After transport, allow the appliance to rest for at least one hour before switching it on.

- Only transport the appliance in its correct position (operating position).

## 5 Description of appliance

This section provides useful information about the installation and operation of this appliance.

### 5.1 Identification

#### # Identification of components

In the following, the parts which are important for understanding the subsequent sections are identified.

- 1 Gallery → for storage of equipment, only permissible while the unit is at a standstill
- 2 All-round bumper → to prevent material damage in the case of a collision
- 3 Caster
- 4 Cooling unit

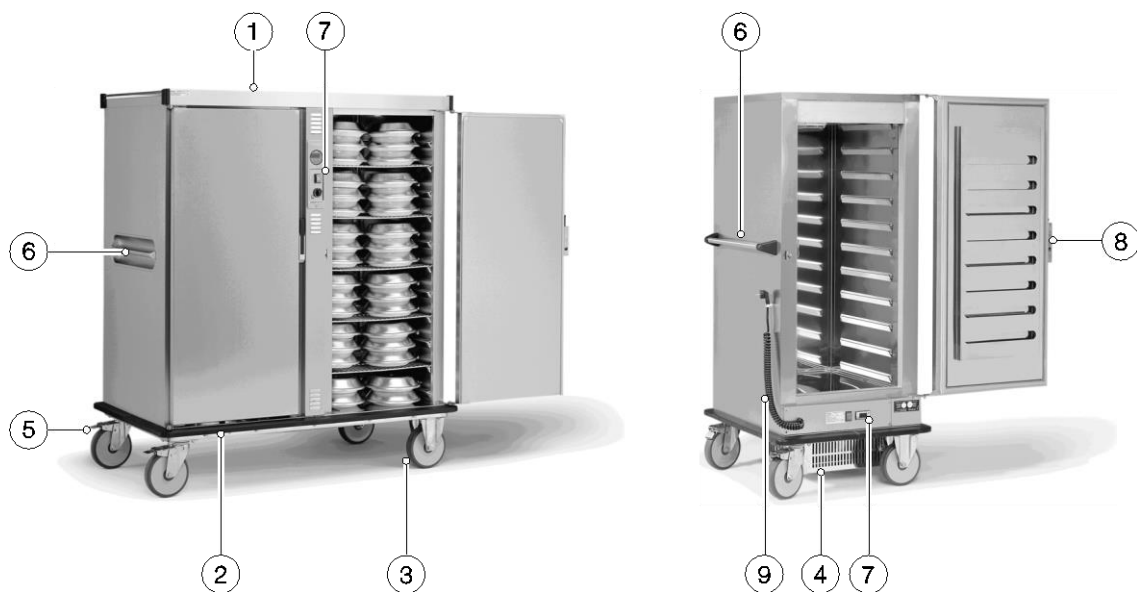

#### # Operating and display elements

- 5 2x caster with parking brake → to prevent rolling away and as 'emergency brake'
- 6 Handle → for pushing the appliance
- 7 Control panel → for controlling the appliance
- 8 Lockable door
- 9 Electric connector and holder

#### # Hot holding function

- The radiant heat on the heating surface produces an air current.
- The air evenly distributed by a fan ensures uniform hot holding of the food/meals.
- Water in the water tank provides for air humidity / steam. The moist air enrichment increases the thermal conductivity and prevents the meals from drying out.

## 5.2 Technical Details

### # General

Permissible ambient temperature +5 °C to +40 °C.

Connected load degree 1N AC 230V 50/60Hz.

Case in chrome nickel steel (material no. 1.4301). Double-walled body, insulated.

4 corner bumpers. Galvanized casters in accordance with DIN 18867, part 8. Wheel diameter 200 mm.

2 swivel casters and 2 swivel casters with brakes. Emission sound pressure level  $L_{pa} < 53$  dB(A)



*Details: see rating plate, catalogue, <http://www.rieber.de>*

### # Type identification

BKW				...	Banquet trolley
BKW	1	x			... Number of doors
BKW	1	x	2/1		... Dimension Gastronorm 2/1
BKW	1	x	2/1	heated	... for hot holding
BKW	1	x	2/1	heated	115 ... vertical clearance between rails
BKW	1	x	2/1	refrigerated	... for cold holding

### # Design types for hot holding

Hot holding range +30 °C to +90 °C with door closed.

Protection class IPX4 according to EN 60529 means: no protection against foreign bodies, protection against water spray from all sides

Designation	Control	Connected load Degree of protection of enclosure	Dimensions BxTxH/ unladen weight	Order no
BKW one door, 1 x 2/1 GN vertical clearance between rails 115	Electronic control	2,25 kW IPX4	777 x 837 x 1711 120 kg	88 23 01 04
BKW one door, 1 x 2/1 GN vertical clearance between rails 70	Electronic control	2,25 kW IPX4	777 x 837 x 1711 120 kg	88 23 01 05
BKW light, one door, 1 x 2/1 GN vertical clearance between rails 115	Manual control	1,75 kW IPX4	777 x 842 x 1674 110 kg	88 23 01 11
BKW light one door, 1 x 2/1 GN vertical clearance between rails 70	Manual control	1,75 kW IPX4	777 x 842 x 1674 110 kg	88 23 01 12
BKW two doors, 2 x 2/1 GN vertical clearance between rails 115	Electronic control	2,9 kW IPX4	1490 x 837 x 1711 200 kg	88 23 02 03
BKW two doors, 2 x 2/1 GN Vertical clearance between rails 70	Electronic control	2,9 kW IPX4	1490 x 837 x 1711 200 kg	88 23 02 04
BKW light two doors, 2 x 2/1 GN vertical clearance between rails 115	Manual control	2,4 kW IPX4	1490 x 837 x 1674 180 kg	88 23 02 11
BKW light two doors, 2 x 2/1 GN vertical clearance between rails 70	Manual control	2,4 kW IPX4	1490 x 837 x 1674 180 kg	88 23 02 12

**# Design types for cold holding**

Cooling range -12 °C to +8 °C with door closed. Refrigerant 134a.

Protection class IPX4 according to EN 60529 means: no protection against foreign bodies, no protection against water

Designation	Control	Connected load Degree of protec tion of enclosure	Dimensions BxTxH/ unladen weight	Order no
BKW-KF, one door, 1 x 2/1 GN vertical clearance between rails 115	Electronic control	600 Watt IPX0	802 x 884 x 1765 150 kg	88 23 04 02
BKW-KF, two doors, 2 x 2/1 GN vertical clearance between rails 115	Electronic control	600 Watt IPX0	1483 x 843 x 1765 215 kg	88 23 04 01

**# Storage capacity**

	<b>BKW 1 x 2/1GN heated vertical clearance between rails 115</b>	<b>BKW 1 x 2/1 GN heated vertical clearance between rails 70</b>
Plates stacked Ø 260 mm	64	64
Plates not stacked Ø 260 mm	44	72
Plates not stacked Ø 310 mm	22	36
	<b>BKW 2 x 2/1 GN heated vertical clearance between rails 115</b>	<b>BKW 2 x 2/1 GN heated vertical clearance between rails 70</b>
Plates stacked Ø 260 mm	160	160
Plates not stacked Ø 260 mm	110	180
Plates not stacked Ø 310 mm	88	144
	<b>BKW -KF 1 x 2/1 GN refrigerated vertical clearance between rails 115</b>	<b>BKW -KF 2 x 2/1 GN refrigerated vertical clearance between rails 115</b>
Plates not stacked Ø 260 mm	40	88
Plates not stacked Ø 310 mm	20	44

Further specifications:



See catalogue, brochure

**5.3 Accessories**

---



**User tip**

With perfect accessories, you will achieve high energy efficiency and can use a wider range of applications.

- Use accessories from Rieber GmbH & Co. KG.



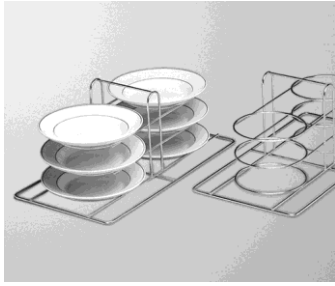

### Accessories

Plate carrier made of stainless steel  
for 6 portioned plates up to Ø 260 mm

### Order no.

88 23 05 01

Stainless steel grilles GN 2/1

84 14 01 01

GN 2/1 lightweight version

84 14 01 06

Stainless steel cloche, single-walled, matt,  
with hole, with groove for deep soup bowl,  
Ø 265 mm, height 49 mm, weight 410 g

89 08 01 31

## 6 Before first use

This chapter describes the measures to be taken before use.

### 6.1 Transport

#### 6.1.1 Check/handle any transport damage

- Immediately after delivery, visually check the appliance for any transport damage.
- Document any potential transport damage on the consignment note in the presence of the haulage contractor, and have the damage confirmed by the haulage contractor (with signature).
- Decide if you wish to keep the appliance and claim the defect using the consignment note, or if you wish to reject the appliance.
  - By following this procedure you will contribute to proper claim settlement.

#### 6.1.2 Unpacking

- Remove any packaging remnants. When doing this, follow the product-specific instructions given on the dispatch note / label on the appliance.
- Check scope of delivery using the dispatch note.
- Remove any protective foils from the appliance.

#### 6.1.3 Dispose of packaging material

- Dispose of packaging material in an environmentally compatible way.

### 6.1.4 Clean the appliance

- Clean the appliance thoroughly before using for the first time.  
Clean with a damp cloth and rub dry with a clean cloth. Rinse the accessories.



See 'Cleaning, maintenance and care', page 24 ff.

## 6.2 Commissioning / recommissioning

---

### Preconditions

- Appliance has no defects or visible damage.
- Appliance has room temperature and is dry.



### NOTE

Protective foils or heat-sensitive objects at/in the appliance might damage the appliance during heating.

- Ensure that there are no protective foils in the inside and on the outside of the appliance.

### # Applies to banquet trolley for refrigerated meals



### NOTE

If transported improperly, e.g. "headlong", the banquet trolley for refrigerated meals might be damaged. There must be sufficient coolant in the coolant tank.

- After improper transport, e.g. "headlong", allow the appliance to rest in its correct position for at least one hour before turning it on.

- Appliances with refrigeration must not be installed near heat sources.
- The ventilation grilles must be accessible.

### Comply with applicable electrical regulations

- Before commissioning, check the mains voltage and type of current.  
Check that these match the specifications on the type plate.
- The socket outlet must be easily accessible so that the unit can be disconnected from power supply at any time.

## 7 Use

### 7.1 Safety instructions on use

#### **Keep to the basic rules for operating the product**

- Regularly check the temperature and ensure HACCP food hygiene guidelines are met. The maximum transport and hot keeping time is 3 hours.
- Do not place any objects on the appliance. Objects might fall down.
- Ensure unobstructed access to the appliance and sufficient lighting.
- The appliance must be disconnected from the power supply during cleaning or maintenance and when replacing parts.
- Connect the appliance to the socket with a pre-switched FI circuit breaker (RCD) with a tripping current of 30 mA.

#### ➤ **WARNING**

Danger of electric shock. Before each use, inspect the appliance, especially the connecting plug and electric cable for any visible signs of damage. Do not use the appliance in the exterior. Protect the appliance against moisture. Install the electric cable such that risks like falling over or tearing off the cable, etc. are avoided.



*Also refer to 'Appliance-specific safety instructions', page 9*

## 7.2 Instructions on use

---

### Use the appliance only for its intended use

- Depending on the application, only use the appliance for heated or chilled food. Application range from -20 °C to +100 °C.



*Also refer to 'Purpose', page 12*

- The banquet trolley can be heated/chilled as required in a heating chamber or cold storage.

### ➤ **NOTE**

Avoid extended exposure of stainless steel to liquid containing salt, as this can lead to surface discolouration and corrosion. Avoid direct, extended contact of stainless steel with corroding iron parts, i.e. kitchen sponge made of steel.

### # To obtain the optimum insulating effect:



#### **User tip**

With perfect accessories, you will achieve high energy efficiency and can use a wider range of applications.

- Use accessories from Rieber GmbH & Co. KG.
- Due to the air convection and the filling state of the appliance, the ACTUAL temperature may deviate from the control temperature. Leave clear space in the appliance.
- Directly after filling, close the appliance and re-open only directly before serving.
- After taking out meals, close the door immediately again.

## 7.3 Banquet trolley with water container for warm food

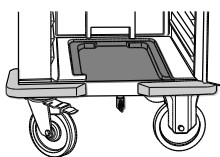

### Prepare <sup>1</sup>

- Close drainage cock. See underside.
- Remove lid from water container, fill with **around 1.5 litres of water**. Put lid on.
- Make sure that there is always water in the water container when using the humidity function. **Top up the water regularly if required.**
  - No error message is issued if there is no water in the tank.



### Switching on the appliance

- Turn the appliance on. Turn the green rocker switch to POWER ON (I).
  - The green rocker switch will light up to signal that the unit is ready for operation.
  - The display shows the ACTUAL temperature.
- To change the target temperature, keep the SET button pressed and use buttons (Δ ▽) to set the value. Release the buttons.
  - The adjusted value is saved automatically.
  - Appliance is heating up.
  - The display shows the ACTUAL temperature.
- After the target temperature has been reached, set the proportion of humidity or water vapour by turning the control knob.
  - The settings greater than '0', i.e. 1 to 3, cause increasing humidity.



### Switching the unit off



- Turn the circulating air intensity off, by turning the control dial to '0'.
- Turn the appliance off electrically. Turn the green rocker switch to POWER OFF (O).
  - The green rocker switch will no longer light up. Empty display, no LED will light up. The appliance is off.
- Pull the electric plug and put it in the holder.

<sup>1</sup> Humidity option

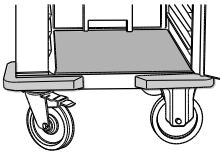
## 7.4 Banquet trolley without water container for warm food



### Switching on the appliance

- Turn the unit on by turning the green rocker switch to POWER ON (I).
  - The green rocker switch will light up to signal that the unit is ready for operation.
- Set the target temperature using the control dial.
  - Setting '1' means approx. 30 °C,  
'2' approx. 60 °C,  
'3' approx. 90 °C.
  - Appliance is heating up.  

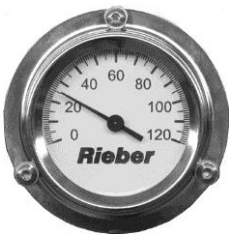
  - The fan will distribute the air uniformly.  
 



- The display in the door indicates the actual temperature in the interior.  

### Switching the unit off

- Turn the appliance off electrically. Turn the green rocker switch to POWER OFF (O).
  - The green rocker switch will no longer light up. The appliance is switched off.
- Pull the electric plug and put it in the holder.

---

## 7.5 Banquet trolley for refrigerated meals with programmable controller

---



### Switching on the appliance

- Turn the appliance on. Turn the green rocker switch to POWER ON (I).
  - The green rocker switch will light up to signal that the unit is ready for operation.
  - The display shows the ACTUAL temperature.
- To change the target temperature, keep the SET button pressed and use buttons (△ ▽) to set the value. Release the buttons.
  - The adjusted value is saved automatically.
  - The appliance is in cooling mode.
  - The display shows the ACTUAL temperature.



---

### Switching the unit off

- Turn the appliance off electrically. Turn the green rocker switch to POWER OFF (O).
    - The green rocker switch will no longer light up. Empty display, no LED will light up. The appliance is off.
  - Pull the electric plug and put it in the holder.
-

## 8 Cleaning, maintenance and care

This chapter will help you to meet with the hygiene requirements. Before reading this section, please read through the "General safety instructions" section thoroughly first.

### 8.1 Safety information relating to cleaning, maintenance and care

---

#### 8.1.1 Avoid dangers due to hot parts or areas

---



##### **WARNING**

One can burn one's hands and arms on the hot surfaces, e.g. the casing, door heating, etc.



- Wear protective gloves.
  - Allow appliance to cool down
- 

#### 8.1.2 Prevent risks due to electricity

---



##### **WARNING**

Danger of electric shock. Risk of death.

- Remove the product from the mains before cleaning.
  - Protect the appliance against moisture. Never direct a jet of water at electrical components such as the heating, control panel or ventilation grille.
  - Check the appliance and connection cable for any damage. A damaged mains cable must be replaced by a qualified electrician.
  - Do not use a steam cleaning unit to clean electrical appliances. Doing so may allow moisture to get into the electrical system and cause a short circuit.
  - Have electrical appliances inspected by a qualified electrician **every six months**<sup>1</sup>.
- 

---

<sup>1</sup> Source: DGUV Regulation 3. Electrical Systems and Equipment



### 8.1.3 Choose the correct cleaning method



#### NOTE

Improper cleaning can damage the surface or even destroy the appliance.

- Be careful not to scratch the surface with sharp-edged objects. Do not use sponges with abrasive surfaces or steel wool or steel brushes.
- Do not use scouring agents or aggressive cleaning agents, such as oven sprays.
- Do not mix standard cleaning agents; do not produce your own cleaning agent.
- Avoid extended exposure of stainless steel to liquid containing salt, as this can lead to surface discolouration and corrosion.
- Avoid direct, extended contact of stainless steel with corroding iron parts, i.e. kitchen sponge made of steel.
- Comply with instructions according to product identification.

### 8.2 Emptying the water tank

---

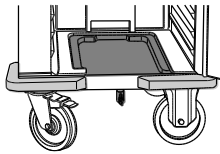

#### Prepare <sup>1</sup>

- Position the unit at a location with a floor drain.

#### Drain remaining water

- Open the drainage cock.
- 

---

<sup>1</sup> Humidity option

## 8.3 Descale the appliance as required

---

### # Inspection of hot holding banquet trolley

#### **i** User tip

The following are reliable scaling indicators:

- The appliance should be descaled before thorough cleaning.

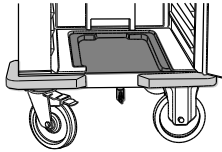

### # Descaling

#### **i** User tip

The surfaces to be treated are made of stainless steel. Improper use of descaling agents may have a negative effect.

- Follow the instructions of the descaling agent manufacturer.

## 8.4 Clean and service stainless steel parts

---

#### **!** NOTE

Improper cleaning can cause damage to the surface.

- Clean the appliance with a **hot, mild detergent diluted in water**. After cleaning, rub surfaces dry with a **soft cloth**.

#### **i** User tip

- We recommend **Rieber cleaning agent for stainless steel** for cleaning stainless steel.

■ It is an especially tough yet gentle cleaner, produces a dazzling shine, cleans and protects in one.

## 8.5 Clean and service plastic parts



### NOTE

Improper cleaning can cause damage to the surface.

- Clean the appliance with a **hot, mild detergent diluted in water**. After cleaning, rub surfaces dry with a **soft cloth**.

## 8.6 Cleaning the seal

- Clean dirty seal. A **hot, mild** washing up detergent diluted in hot water is ideal for cleaning. After cleaning, rub surfaces dry with a **soft cloth**.

## 8.7 Cleaning the casters



### NOTE

Cleaning the casters incorrectly can damage them. When the casters are cleaned with a steam cleaner, the lubricant may be flushed out of the wheel bearing.

- Clean the casters with a **hot, mild detergent diluted in water**. After cleaning, rub surfaces dry with a **soft cloth**.

## 8.8 Cleaning the ventilation grille of the appliance for cold holding



### WARNING

Risk of fire. Fluff in the ventilation area can cause a build-up of heat which could result in a fire.

- Clean ventilation grille at refrigerating engine compartment using a cloth, paintbrush or vacuum cleaner (at least once a month).



## 8.9 Defrosting the appliance for cold holding

---



### User tip

- The appliance may ice up.
- Defrost the appliance when it has iced up.
  - After that, clean it.

## 8.10 Have coolant filling level checked

---



### User tip

- The banquet trolley for cold holding may lose coolant. Loss of coolant may reduce the refrigeration output or damage the refrigerating unit.
- The manufacturer recommends yearly inspection by a refrigeration expert.

## 8.11 Keep ready for next use in dry condition

---

- Dry the inside of the appliance and leave the door open until the residual moisture has dried off.
- Store appliance at room temperature.



Fault	Possible cause	Repair
	Food not pre-chilled sufficiently	<ul style="list-style-type: none"> <li>➤ Check</li> <li># Operating staff</li> </ul>
	Appliance was filled with hot or insufficiently pre-cooled meals	<ul style="list-style-type: none"> <li>➤ Check</li> <li># Operating staff</li> </ul>
	Not enough coolant in appliance	<ul style="list-style-type: none"> <li>➤ Fill in coolant.</li> <li># Refrigeration expert</li> <li># Rieber Service or authorized partner</li> </ul>
Caster defective	wear, damage	<ul style="list-style-type: none"> <li>➤ Replace</li> <li># Qualified mechanic</li> </ul>

**# Customer service, spare parts**



See Internet <http://www.rieber.de>



**IMPORTANT**

Customer services needs information about the type and number of the appliance.

- If you have a fault you cannot remedy yourself, please get in touch with your Rieber partner or Rieber central customer services.

**# Disposing of your product**



Your appliance is made of high-quality material which can be reused / recycled. For disposal, disconnect the appliance from mains supply. Unplug the mains plug. Cut off the cable directly at the casing. Dispose of this appliance properly via your local disposal facility.

➤ **⚠ WARNING**

Danger of suffocation if persons get locked in the appliance. Protect the appliance from by persons with limited sensory and mental ability. Destroy the door lock.

## 10 Warranty and liability

Manufacturer liability and warranty shall no longer apply if

- you do not follow the information and instructions in this user guide,
- you use the appliance for any purpose other than the intended use,



*See chapter "Intended use"*

- you make conversions or functional modifications,
- you use non-original spare parts.

The manufacturer's "Sales and delivery terms and conditions" shall apply for all warranty claims. For instance, any repairs and/or overhaul during the warranty period may only be performed by the Rieber service department, otherwise any resulting claims may be void. Please contact the manufacturer.

The following wearing parts are not included in the warranty:

- Caster/caster with parking brake, bumper corner

## 11 Excerpt from the EU Declaration of Conformity

The manufacturer herewith declares that the product

- Banquet trolley, heated
- Banquet trolley, cooled

complies with the basic requirements

- EC Machinery Directive 2006/42/EC
- Directive 2014/35/EU (Low Voltage Directive)
- Directive 2014/30/EU on Electromagnetic Compatibility
- Directive 2011/65/EU RoHS

If required, a copy of the EU Declaration of Conformity can be obtained from our sales team.

## 12 Contact address

Rieber GmbH & Co. KG  
Hoffmannstraße 44  
D 72770 Reutlingen, Germany  
Phone +49 (0) 7121 518-0  
FAX +49 (0) 7121 518-302  
Email [info@rieber.de](mailto:info@rieber.de)  
[www.rieber.de](http://www.rieber.de)