



Appliances for food delivery, available as table-top or built-in version

**- Bain-Marie**



Mobile appliances for food delivery /food distribution

**- Delivery Trolley**

**- Food Transport Trolley**

The illustrations show configuration examples, which do not necessarily have to be included in the scope of delivery.



Please read Operating Instructions beforehand  
Translation of the Original Operating Instructions

DOWNLOAD: USER MANUAL

QR code on type plate



EN

# Contents

<b>1</b>	<b>Revision Index.....</b>	<b>3</b>
<b>2</b>	<b>Important Information .....</b>	<b>3</b>
2.1	The components of the technical documentation .....	3
2.2	Using this guide .....	4
2.3	Representation conventions in the text .....	5
2.4	Structure of safety instructions .....	6
<b>3</b>	<b>General safety instructions.....</b>	<b>7</b>
3.1	General behaviour .....	7
3.2	On use of electrical appliances .....	7
3.3	Operator's obligations .....	8
3.4	Personnel qualification requirements .....	9
3.5	Personal protective equipment (PPE) must be readily available for personnel.....	9
3.6	Appliance-specific safety instructions.....	10
3.7	Information about regulations to be followed .....	15
3.8	Instructions on behaviour in an emergency.....	15
<b>4</b>	<b>Designated purpose of use.....</b>	<b>16</b>
<b>5</b>	<b>Equipment Descriptions .....</b>	<b>18</b>
5.1	General technical data .....	18
5.2	Food transport trolleys .....	19
5.3	Delivery trolleys.....	25
5.4	Bain-marie .....	27
<b>6</b>	<b>Facts from delivery to the first cleaning.....</b>	<b>30</b>
<b>7</b>	<b>Use .....</b>	<b>31</b>
7.1	Safety information with regard to use.....	31
7.2	Instructions for use of the bain-marie .....	34
7.3	Instructions for use of appliances with "Refrigerated cupboard" .....	36
7.4	Instructions for use of appliances with "Heated cupboard" .....	37
7.5	Clean the appliance daily after use. ....	38
<b>8</b>	<b>Cleaning, Maintenance and Care .....</b>	<b>38</b>
8.1	Safety information relating to cleaning, maintenance and care .....	38
8.2	Cleaning agents for stainless steel.....	39
8.3	Choose the correct cleaning method.....	40
8.4	Overview of intervals.....	41
8.5	Drain water bain-marie.....	42
8.6	Clean the bain-marie.....	42
8.7	"Refrigerated cupboard".....	43
8.8	"heated cupboard" .....	43
8.9	Clean castors .....	43
8.10	Descale the bain-marie if necessary .....	44
8.11	Keep ready for next use in dry condition .....	44
<b>9</b>	<b>Troubleshooting – What now?.....</b>	<b>45</b>
9.1	Notes on troubleshooting .....	45
9.2	Disposing of your product .....	46
<b>10</b>	<b>Warranty and liability .....</b>	<b>47</b>
<b>11</b>	<b>Excerpt from EC Declarations of Conformity .....</b>	<b>47</b>
<b>12</b>	<b>Manufacturer's address .....</b>	<b>48</b>

## 1 Revision Index

Revision	Change
2012-05-11	New edition
2013-02-20	Temperature 100°C
2013-04-19	Output of black/white printing data
2014-08-05	Technical data supplemented
2016-12-15	General change
2019-06-13	Digital control added; STW K POT®-III-2 KW

## 2 Important Information

### 2.1 The components of the technical documentation

- Operating Instructions
- Information on **CHECK HACCP**  
[www.rieber.de](http://www.rieber.de)  
 Select "→ Service" at the top of the display list.
- Spare parts and necessary instructions.  
[www.rieber.de](http://www.rieber.de)  
 Select "→ Customer Service" at the top of the display list.
- The Rieber price guide provides further information about a wide variety of accessories.  
[www.rieber.de](http://www.rieber.de)  
 At the top of the display list, select: Search → price guide  
 Or: Contact the manufacturer, Rieber, or your dealer
- Do you wish to have the operating instructions in another language?  
[www.rieber.de](http://www.rieber.de)  
 Select "→ Customer Service" at the top of the display list.



## 2.3 Representation conventions in the text

... **Highlighting** ... , is a text fragment, which must be emphasized

- Lists are represented in this way.
- Instructions on certain actions are represented in this way.



See '...' , *cross-references are represented in this way*



### CAUTION

indicates potential damage to property without any personal injury.

Failure to follow these instructions may cause damage to property.



### User tip

- Useful information or tip

# Explanation of graphic symbols used



Empty weight



Maximum loading

### 2.4 Structure of safety instructions

---

The signal words DANGER - WARNING - CAUTION classify the degree of risk of bodily injury in an actual situation. You can avoid injury by complying with the behavioural rules provided.

The warning triangle symbol indicates a "General Danger".

---



#### **DANGER**

indicates **imminent danger**.

Failure to follow these warning instructions will result in **serious bodily injury or even death**.

---



#### **WARNING**

indicates a **potentially hazardous situation**.

Failure to follow these warning instructions **may** cause **serious bodily injury or even death**.

---



#### **CAUTION**

indicates a **potentially harmful situation**.

Failure to follow these warnings **may** cause **minor bodily injury**.

---

## 3 General safety instructions

This section covers residual risks and hazards associated with the intended use of the appliance. We have provided a list of all generally valid safety instructions which must be followed.

In the following section, safety information relating to a particular operation or situation is placed before the appropriate operation step or description of the situation.

The information provided here such as 'Basic rules of conduct', 'Operator's obligations' etc. only refers to the legally required observance of requirements such as the Workplaces Ordinance (ArbStättV) according to German law.

### 3.1 General behaviour

This appliance meets the current state of the art and complies with all acknowledged technical safety-related regulations. Nevertheless hazards may still arise.

- Only use this appliance when it is in fault-free condition and according to the instructions in this user guide.
- During all phases of the product's life please ensure that the product is safely integrated into its environment.
- Refrain from rearranging or changing the device.

### 3.2 On use of electrical appliances

Safety instructions according to EN 60745-1:

#### Work area

- Keep your work area clean and tidy. A messy or unlit work area can cause accidents.
- Keep children and other people away from the area when work is being carried out.

#### Electrical safety

- The plug on the unit must fit in the socket. Do not modify the plug in any way. Never use an adapter in combination with earthed appliances. Using an unmodified plug and a suitable socket will reduce the risk of an electric shock.
- Keep the device away from rain or wet. Allowing water to get into an electric appliance will increase the risk of electric shock.
- Do not use the cable for anything other than the intended purpose to disconnect the plug from the socket. Always remove whilst holding onto the plug. Keep the cable away from heat, oil, sharp edges or the moving parts of other appliances. Using damaged or tangled cables increases the risk of electric shock.
- When working with an electrical appliance outdoors, only use extension cables which are permitted for outdoor use. Using an extension cable suitable for outdoor use reduces the risk of electric shock.
- Potential risk of fire due to heat build-up. Unwind the cable from the cable drum to prevent a possible heat build-up and/or cable fire. The coupling must have splash protection, must be made of rubber or be rubber-coated.

#### Safety guidelines for persons

- Be attentive and pay attention to what you are doing, act rationally when working with an electrical appliance. Do not use the appliance when tired or under the influence of drugs, alcohol or medication.  
Just one moment of inattention whilst using the appliance can result in serious injury.

- Make sure the appliance cannot be switched on unintentionally. Double check that the main switch is in the "OFF" position before inserting the plug in the socket. Connecting the appliance to the power supply while it is switched on can cause an accident.

### Careful handling and use of electrical appliances

- Never use an electrical appliance with a faulty switch. An electrical appliance which can no longer be switched on or off is dangerous and must be repaired.
- Keep unused electrical devices away from children. Do not allow the appliance to be used by persons who are not familiar with it or persons who are not familiar with this user guide. Electrical appliances are dangerous when in the hands of inexperienced persons.
- Treat the device with care. Check that moving parts are functioning properly and do not block; check whether parts are broken or damaged and impairing the functioning of the device. Have any damaged parts repaired before using the appliance. Many accidents are caused by poorly-maintained electrical appliances.
- Use electrical appliances, accessories etc in accordance with these instructions and in a manner that is specified for this particular appliance type. When using the appliance, please take into account the working conditions and the work being carried out. Using electrical appliances for other uses than that intended can lead to hazardous situations.

### Service

- Only have the device repaired by qualified and authorised staff. Only use original spare parts. In this way you can ensure that the appliance remains safe.

## 3.3 Operator's obligations

---

### Operator

The operator is the person who operates the appliance for commercial or economic purposes either himself/herself or lets others use it and bears the legal appliance responsibility for protection of the user, staff or any third parties during operation.

### Operator's duties

The appliance is used in commercial applications. For this reason, the operator of the appliance must meet all legal duties relating to work safety.

In addition to the safety instructions in this guide, the safety, accident prevention and environmental protection regulation applying to the application of the appliance must be complied with.

In particular, the following shall apply:

- The operator must be familiar with the applicable work safety regulations and identify, by carrying out a risk analysis, any additional hazards which are due to the place where the appliance is used. These hazards must be addressed in the form of operating instructions governing the operation of the appliance.
- Throughout the period of use of the device the operator must check that the operating instructions which he has compiled comply with the current regulations and adapt them if necessary.
- The operator must clearly regulate and define the responsibilities for installation, operation, troubleshooting, maintenance and cleaning.
- The operator must ensure that all employees who use the device have read and understood these instructions. In addition, the operator must train the personnel and inform them of the hazards involved at regular intervals.
- The operator must provide the personnel with the necessary protective equipment and issue mandatory instructions on wearing it.

In addition, the operator must ensure that the appliance is always in a perfect technical condition. For this reason, the following shall apply:

- The operator must ensure that the maintenance intervals defined in this guide are obeyed.



- The operator must regularly check all safety devices for functionality and completeness.
- The operator must ensure that the appropriate media connections are present.
- The operator must ensure that structural safety measures are performed.

### 3.4 Personnel qualification requirements

Safe operation requires certain technical skills and personal qualification of each person.

- The responsibility for organization lies with the '**Designated Representative**' (operator).  
According to EN 50110-1 a work supervisor is a person who is appointed to take direct responsibility for the performance of work. If necessary, this responsibility can be assigned partly to other persons. [...] The designated representative must instruct all persons involved in the work on all hazards which may not be obvious for them'.
- The work may only be performed by '**instructed persons**' who have been trained accordingly. Training, instructions must be repeated, proper understanding must be verified (ideally by way of an appropriate test).
- Only '**Qualified Staff**' are allowed to carry out repair work.  
IEC 60204-1 defines qualified personnel as "persons who, on account of their training and relevant experience are in the position to recognise risks and avoid potentially dangerous situations."
- Electrical work may only be carried out by trained and experienced **electricians**. Electro-technically instructed persons may only work under the supervision of a qualified electrician.
- Applies to **bain-marie** in built-in version for welding-in: Welding work should only be carried out by a trained **welding expert** with experience in machining stainless steel.
- Work on the cooling unit should only be carried out by authorised skilled personnel like a **refrigeration specialist** or a member of the Rieber Customer Service.
- Any repairs and/or overhaul during the warranty period may only be carried out by the manufacturer's service department.



See 'Warranty and liability', page 47

### 3.5 Personal protective equipment (PPE) must be readily available for personnel

The requirements for safety shoes are regulated by standards. The safety shoes in this case are intended to protect the toes. S1 safety shoes are protective shoes with the requirement that a protective toecap is present. As with S2 and S3 safety shoes, the protective toecap has a load capacity of 200 joules. These requirements are regulated in EN 20345:2004 for safety shoes.

- Ensure that the personnel wear the personal protective equipment appropriate to the relevant situation.
- Wear safety shoes to prevent injuries during transport of the appliance.
- Wear safety gloves to avoid burns at hands and arms.

### 3.6 Appliance-specific safety instructions

---

This chapter describes general, appliance-specific safety instructions. In the following section, additional safety information relating to a particular operation or situation is placed before the appropriate operation step or description of the situation.

#### 3.6.1 Risks due to electricity

- Before each use, inspect the product, the connecting plug and electric cable for any visible signs of damage.
- The cable must be routed so that it cannot be squeezed or overheated.
- The socket outlet must be easily accessible so that the unit can be disconnected from the power supply at any time.

#### 3.6.2 Risks due to transport of mobile appliance

Numerous hazards such as crushing can arise when transporting this heavy product.

- Do not pull the appliance, always push it using the pushing handle. This will also give you a better overview and allow direct access to the 'castors with parking brake'.
- Use the two parking brakes to prevent the device from rolling away accidentally. Only park the device on flat surfaces.
- Keep the door and the sliding lid closed during transport.
- The doors are self-closing. Press the slider down to additionally secure the closed door if necessary.
- Only transport unit on a straight surface. Do not transport on a sloping surface.
- Carry out transport with an adequate number of people.
- Transport only permissible using the castors.
- Wear safety shoes to prevent injuries.



#### CAUTION

Uneven ground such as edges, ridges or thresholds can damage the casters.

- Only move the appliance over flat, smooth surfaces. Do not push or pull the appliance over sharp edges.
- Note the permissible step height, maximum 4 mm, otherwise the casters may be damaged.
- Do not use this appliance on poor floor conditions. We are not able to rule out the possibility of marks appearing on the floor due to friction with castors or the formation of scratches due to split cracks in the castors, for example.

### 3.6.3 Risk of burning and scalding

**Risk of burning** hands and arms on hot parts such as the **bain-marie** and 'heated cupboard'.

**Risk of scalding** to face and hands from hot steam from the **bain-marie**.

- Take care when handling the hot **bain-marie** and the 'heated cupboard' (optional).
- Wear personal protective equipment such as protective gloves, which will prevent you from burning your arms or hands when working close to hot parts.

### 3.6.4 Risk of slipping and falling

Transporting

Sliding lid in heating position

Opened for serving food

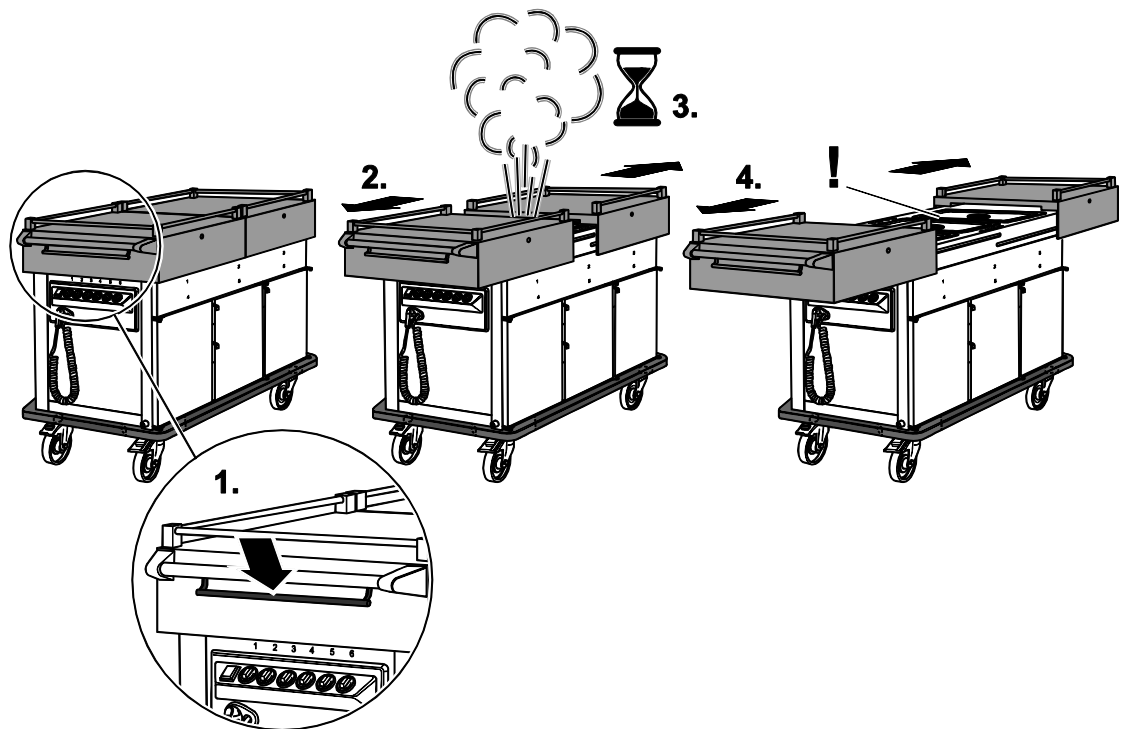

**Risk of slipping and falling.** Steam from the bain-marie may condense on the inner sides of the sliding lid, so that condensation drips onto the floor.

- Completely cover the **heated well** and the **bain-marie** with a GN container and matching lid. This should be observed particularly if used as a **water bain-marie**.

Open the sliding lid **in two stages**. To do this:

- Press the frame down to open; pull the handle and release the frame.
  - The sliding lid locks. Steam escapes from the opening between the sliding lids.
- Repeat this with the other sliding lid.
- Wait until the intensively rising steam has escaped.
- Press the frame down to open the sliding lid completely. Pull the handle to move the sliding lid into the end position.

# Note the position of the **discharge tap**:

- Pay attention to the position of the discharge tap. Keep unauthorised persons away from the appliance.

# **Also** note:

- Open the sliding or hinged lid during heating as a **water bain-marie**.
- Wipe the underside of the sliding lid or inner side of the hinged lid dry if necessary with an absorbent non-scratch cloth.
- Pay attention to the position on the water drain "OPEN – CLOSED".

Example

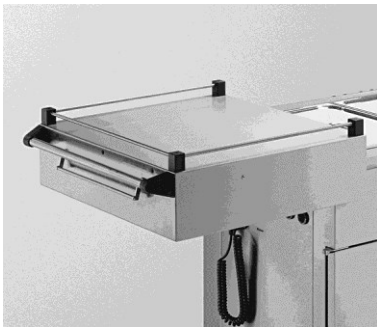

Sliding lid opened



Hinged lid opened

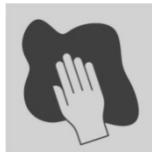

- Wipe moisture up immediately with an absorbent non-scratch cloth.

### 3.6.5 Risks due to opened technical compartment

The version with a "chilling compartment" has a refrigeration unit in the technical compartment.

**Risk of injury** on moving parts, the **impeller wheel**, when technical compartment is open.

- Before carrying out repairs in the technical compartment switch off the electrical power to the appliance by unplugging the mains plug.
- Keep the technical compartment closed. Use a suitable tool to open and close the technical compartment.

### 3.6.6 Risks due to interrupted cooling

# **Risks due to interrupted cooling**

Compliance with HACCP requirements could be at risk if cooling is interrupted, for example due to a power failure. No error message is given in the event of a power failure.

- Do not operate the appliance unsupervised. Observe the operating display.

### 3.6.7 Warnings concerning the use of the appliance by children

- This appliance may be used by children over 12 and by persons with limited physical, sensory and intellectual abilities or a lack of experience and/or knowledge if they are supervised or if they have been instructed in the safe use of the appliance and have understood the resulting dangers.
- When using the appliance with 'accessories', other risks may arise.
- Children may not play with the appliance.
- Cleaning and user maintenance may not be carried out by children without supervision.

### 3.6.8 Safety and monitoring devices

#### Mobile appliances

- The doors are self-closing. Press the slider down to additionally secure the closed door if necessary.
- Switching elements are shock-protected on mobile appliances
- Push the appliance using the push handle; this will also give you a better overview and allow direct access to the 'castors with parking brake'.
- The corner bumpers offer impact protection and prevent damage.

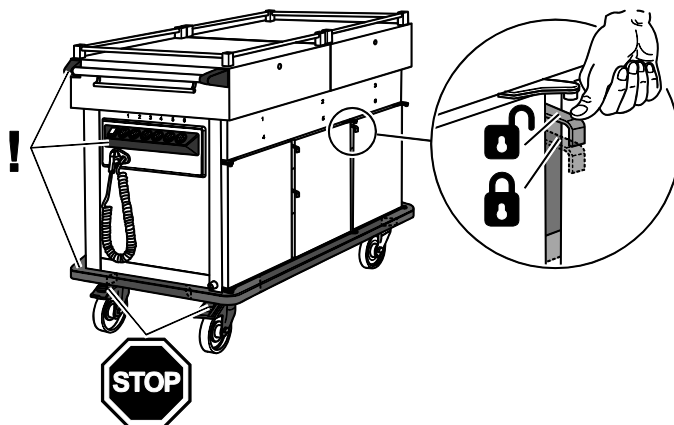

#### # Bain-Marie

- The ridge edge provides protection against overflowing liquid.

#### # Cooled cupboard

- The appliance has an indicator light for 'Switched ON/OFF' operating status, which lights up green when the appliance is switched on.

### 3.6.9 Note the product identification and ensure its preservation

#### # General

The type plate bears the legally required product data.

Safety note on electrical hazards "Remove mains plug before opening the appliance".

#### # Identification of control points

example



The operator's controls are marked with reference to the functional points.

example

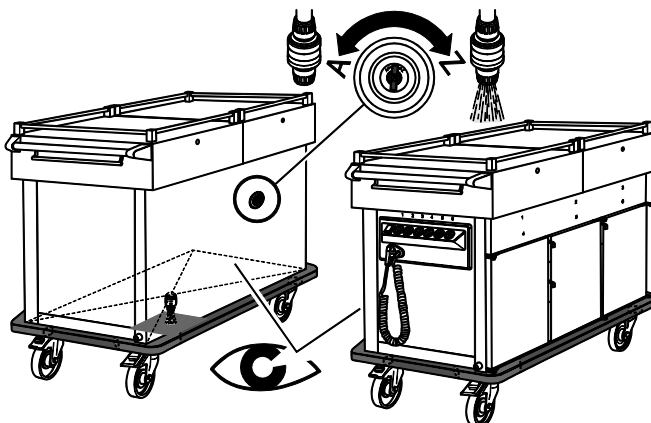

Water drainage; Controller in position A = OPEN, controller in position Z = CLOSED

- Heated compartment is not marked
- Refrigerated compartment is not marked.
- Technical compartment is not marked.
- Sliding lid is not marked. No note on opening. No note on maximum permissible load, load full area with **maximum 40 kg**.
- Hinged lid is not marked. No note on maximum permissible load, load full area with **maximum 15 kg**.

### # Bain-Marie

The **bain-marie** is not marked.

- **Bain-marie** on delivery trolleys and food transport trolleys can be used as a **dry bain-marie** and as a **water bain-marie**.
- **Bain-marie** as table-top or built-in version is a **water bain-marie**.

## 3.7 Information about regulations to be followed

---

In addition to this user guide there are a range of health and safety and other regulations that are relevant for the operation of this cooking station; these include HACCP food hygiene regulations for example.

## 3.8 Instructions on behaviour in an emergency

---

- In an emergency always interrupt the power connection immediately, by disconnecting the electrical connector.

### **First aid in the case of burns and scalding or electric shock**

- Inform yourself on this before commissioning the appliance.
- Store the emergency equipment, including the relevant instructions, at a readily accessible place near the place of use.



### **User tip**

- You can find detailed information in the company's internal instructions.
- We recommend that half-yearly emergency training sessions should be carried out.

### 4 Designated purpose of use

This chapter provides information on the intended use of the product and warns against foreseeable misuse or abuse, for your safety. Use the appliance for its intended use.

#### **⚠ Intended use in principle means:**

- For service in catering, hotels and restaurants; also suitable for the care and school catering sectors. Not intended for private use at home.
- For food delivery / meal distribution at home.
- To prevent injuries such as burns on hot surfaces, use of the product by the public or for self-service should only be allowed under supervision.
- The designated purpose of use includes compliance with the technical data.
- For use only by appropriately trained and suitable operating personnel.

#### **# Bain-Marie**

- Intended for keeping food warm.
- The **bain-marie** on delivery trolleys and food transport trolleys can be used as a **dry bain-marie** and as a **water bain-marie**.
- **Bain-marie** as table-top or built-in version is a **water bain-marie**.
- **Bain-Marie 4.0** can be used as a **water bain-marie**.
- Use GN container with a matching lid.
- Only transport hot liquids in closed GN container with press-in lid.

#### **# Heated cupboard**

- Intended for keeping food warm.

#### **# Chilling compartment**

- Intended for daily chilling of meals and beverages.
- Store meals and beverages closed or covered, do not keep open.
- Open the refrigerated compartment for filling or removal for as short a time as possible.
- Move and chill the food correctly daily after use, switch off and clean the appliance.

#### **# Delivery trolleys**

- Delivery trolleys serve for transporting and dispensing food.

#### **# Food transport trolleys**

- Food transport trolleys are used for food transport, keeping food warm in the heated cupboard and for dispensing.



**⚠ Prevent any predictable misuse and abuse:**

- A **bain-marie** which is intended to be 'wet-heated' should only ever be wet-heated.
- Do not fill hot or overheated **bain-marie** - after water loss, for example - with water. Allow the appliance to cool down first. Only then fill with water.
- Do not lean against or sit on the appliance.
- Keep any combustible or explosive fluids away from heatable appliances. Otherwise a fire or explosion may occur.
- Do not use the appliance in aggressive ambient conditions, for example extremely salt-laden air such as close to the sea or at a swimming pool with a chlorinated atmosphere, as this could damage the stainless steel.
- Incorrect cleaning can substantially and irreparably damage the stainless steel surfaces.
- Do not use this appliance on poor floor conditions.  
We are not able to rule out the possibility of marks appearing on the floor due to friction with castors or the formation of scratches due to split cracks in the castors, for example.  
We are not able to rule out the possibility that the castors may be damaged or become unusable due to swelling or sharp edges on the floor.
- Mobile appliances may only be moved manually. Machine-aided transport, e.g. using fork lift trucks or lift trucks, is not permissible.

## 5 Equipment Descriptions

This chapter provides useful information on the structure and function of the equipment.

### 5.1 General technical data

Rated voltage / mains frequency	1N AC 230V 50/60Hz
Electrical connection	Approx. 2 m cable length
<b>Bain-marie</b>	<p>Worktop with ridge edge. Deep-drawn heated well (bain-marie), welded-in. Hygienic design H3.</p> <p>1 heating element per heated well, heat output separately adjustable. ON/OFF rocker switch, Thermostat-controlled from <b>+30 °C to +110 °C</b>.</p> <p>Well size for Gastronorm container GN 1/1 to 200 mm</p>
Cupboard	<p>1 heating element per cupboard 1/1, heat output separately adjustable. Thermostat-controlled from <b>+30 °C to +110 °C</b>. Hygienic design H3.</p> <p>8 / (14) pairs of seamless deep-drawn support rails, clearance 37 mm, for holding GN containers up to GN 1/1. Doors double-walled and self-closing.</p>
Loading excluding cupboard and bain-marie	maximum 20 kg, evenly distributed
Protection class for <b>bain-marie</b> / heated well	<p>IPX5 in accordance with DIN EN 60529</p> <p>Protected against water jets from all directions</p>
Protection class for heated cupboard	<p>IPX5 in accordance with DIN EN 60529</p> <p>Protected against water jets from all directions</p>
Protection class for cooled cupboard	<p>IPX3 in accordance with DIN EN 60529</p> <p>Protected against spraying water up to 60° on either side of the vertical</p>
Protection class for Delivery trolleys	<p>IPX5 in accordance with DIN EN 60529</p> <p>Protected against spraying water up to 60° on either side of the vertical</p>
Emitted sound pressure level	$L_{pa} < 70 \text{ dB(A)}$
Permissible ambient temperature	+5 °C to +40 °C

NOTE: If an appliance is designed with several equipment features, the lower protection class applies for this appliance.

DIN 18865-9:1997 Food Distribution Equipment, Part 9 is complied with.

Hygienic version H 3 means: Floor, walls and cover welded tightly and gap-free.  
All curvatures  $\geq 10 \text{ mm}$ .

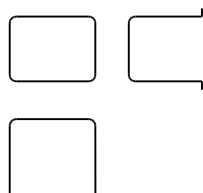

Material stainless steel

Doors double-walled, insulated. Doors self-closing. Transport lock. Interior sealed by welding, hygienic design H3.

Rustproof casters in accordance with DIN 18867, Part 8. Wheel diameter 125 mm. 2 fixed castors, 2 swivel castors. Push handle. Corner bumpers.

ON/OFF rocker switch

## 5.2 Food transport trolleys



### 5.2.1 Model Norm-II-O and Norm-III-O



Norm-II-0



Norm-III-0

Type / Order no.:	Type	Dimensions L x W x H [mm]	Connected load [W]		
Norm-II-0 88 13 03 23 *	2x heated cupboard, 14 pairs of beading for GN 1/1, 330 x 570 x 586 mm	905 x 680 x 900 (947)	940	75	140
Norm-III-0 88 13 10 23 *	3x heated cupboard, 14 pairs of beading for GN 1/1, 330 x 570 x 586 mm	1 314 x 680 x 900 (947)	1 410	110	140

#### # Accessories:



Chapter 'Accessories', page 22



5.2.2 Model Norm-II-2 and Norm-III-3



Norm-II-2  
(with additional heat well at the top).  
Gastronorm containers are accessories.



Norm-III-3  
(with additional heat well at the top).  
Gastronorm containers are accessories.

Type / Order no.:	Type	Dimensions L x W x H [mm]	Connected load [W]		
Norm-II-2 88 13 06 23 *	2x heated cupboard, 14 pairs of beading for GN 1/1, 330 x 570 x 586 mm	905 x 680 x 900	1 880	75	140
Norm-III-3 88 13 14 23 *	3x heated cupboard, 14 pairs of beading for GN 1/1, 330 x 570 x 586 mm	1 314 x 680 x 900	2 820	85	140

# Accessories:





Chapter 'Accessories', page 22

5.2.3 Model Norm-III-1-1K







Norm-III-1-1K  
(with additional heat well at the top).  
Gastronorm containers are accessories.

Type / Order no.:	Type	Dimensions L x W x H [mm]	Connected load [W]		
<p><b>Heated cupboard</b> (left).  <b>Refrigerated cupboard</b> (right). Refrigerating capacity separately adjustable. Thermostat-controlled, refrigeration range from <b>+2 °C</b> to <b>+10 °C</b>, refrigerating capacity 118 W at -10 °C, evaporation temperature, refrigerant R 134a.</p>					
Norm-III-1-1K 88 13 18 23 *	1x heated cupboard, (left). 1x refrigerated cupboard, (right). 8 pairs of beading, spacing 37 mm for GN 1/1, 330 x 570 x 483 mm	1 314 x 680 x 900	1 970	90	140

# Accessories:

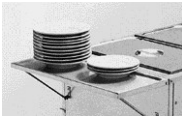
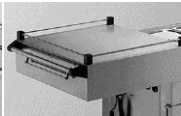
 Chapter 'Accessories', page 22





5.2.4 Accessories

				No illustration	
Shelf hinged at front	Sliding lid, insulated, extendable beyond the front. Locking position, 100 mm indexing position for preheating.	Hinged lid. Size splitting: 1/3 operator side, 2/3 at rear	Attachment with light/heat bridge (not in combination with sliding lid or hinged lid)	Attachment with light bridge (not in combination with sliding lid or hinged lid)	Insert frames for compartment, pull-out, for GN containers up to 1/1, High compartment = 4 frames, Low compartment = 2 frames
L x W x H [mm] 612 x 265 x 22	Norm II: 996 x 680 x 1006 Norm III: 1406 x 680 x 1006	Norm II: 905 x 680 x 925 Norm III: 1314 x 680 x 925			
Order no. Norm II 88 13 20 02	88 13 20 69	88 13 20 71	88 13 20 46	88 13 20 45	88 13 20 57 (for 1xGN1/1)
Norm III 88 13 20 02	88 13 20 70	88 13 20 72	88 13 20 48	88 13 20 47	88 13 20 58 (for 2xGN1/2)
Norm III-1-1K 88 13 20 02	88 13 20 70	88 13 20 72	—	—	—

# Note on frames

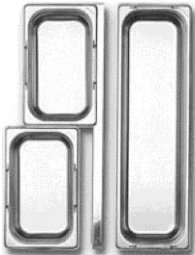
Frames for the division of heated wells, so that smaller containers, e.g. GN 1/4, can be used.



The frames are inserted as an edge support for smaller containers in the combination 2/1 or 1/1 in length or width. Stability is also ensured by an integrated spring.

Longitudinal frame set		Horizontal frame set	
			
GN size 1/1 	Length: 530 mm Order no. 84 19 01 01	GN size 1/1 	Length: 325 mm Horizontal frame with spring Order no. 84 19 02 01  Length: 325 mm Horizontal frame without spring for <b>thermoport</b> ® 100/50 K Order no. 84 19 02 02

5.2.5 Model Norm-II-Super



Norm-II-2-Super  
 (with additional heat well at the top).  
 Gastronorm containers are accessories.  
 Hinged lids are optional.

Type / Order no.:	Type	Dimensions L x W x H [mm]	Connected load [W]		
Norm-II-Super 88 13 15 11 *	Heated cupboard, (left and right). Cupboard open, not heated. 6 pairs of beading, spacing 55 mm for GN 1/1, 530 x 365 mm	1 078 x 700 x 935	2 639	101	140

# Accessories:





Chapter 'Accessories', page 22

5.2.6 STW K|POT®-III-2 KW



STW K|POT®-III-2 KW  
(with additional heat well at the top).  
Gastronorm containers are accessories.

Type / Order no.:	Type	Dimensions L x W x H [mm]	Connected load [W]		
STW K POT®-III-2 KW 88 13 23 01	<p>2 heated wells, individually heatable. Retractable step switch, from 0 to 9. Power from 0 to 800 Watt, electronic control unit.</p> <p>1 cooling trough. Ball drain valve at the rear of the unit.</p> <p>Heated cupboard, 470 Watt. Cooled cupboard.</p> <p>4 pairs of beading, spacing 37 mm for GN 1/1, 325 x 530 mm.</p>	1314 x 680 x 900	2420	100	140



### 5.3 Delivery trolleys

#### # Delivery trolley, also dry-heated



ZUB 1



ZUB 2

ZUB 2-GL





ZUB 3

ZUB 3-GL



ZUB 4

ZUB 4-GL

Type / Order no.:	Type	Dimensions L x W x H [mm]	Connected load [W]		
ZUB 1 88 16 01 01 *	1 x GN 1/1, 200 mm	758 x 475 x 900	0.47	22	140
ZUB 2 88 16 02 01 *	2 x GN 1/1, 200 mm	858 x 675 x 900	0.94	33	140
ZUB 2-GL 88 16 02 03 *	2 x GN 1/1, 200 mm	816 x 717 x 900	0.94	33	140
ZUB 3 88 16 03 01 *	3 x GN 1/1, 200 mm	1 227 x 675 x 900	1.41	44	140
ZUB 3-GL 88 16 03 03 *	3 x GN 1/1, 200 mm	1 185 x 717 x 900	1.41	44	140
ZUB 4 88 16 04 01 *	4 x GN 1/1, 200 mm	1 562 x 675 x 900	1.88	55	140
ZUB 4-GL 88 16 04 03 *	4 x GN 1/1, 200 mm	1 520 x 717 x 900	1.88	55	140



#### # Accessories:



Chapter 'Accessories', page 22

# Delivery trolley, refrigerated



Type / Order no.:	Type	Dimensions L x W x H [mm]	Connected load [W]		
Refrigeration range from <b>+2 °C to +10 °C</b> , refrigerating capacity 118 W at -10 °C, evaporation temperature, refrigerant R 134a.					
ZUB 2-K 88 16 08 01 *	2 x GN 1/1, 200mm 639 x 510 210 mm	860 x 663 x 900	255	55	140
ZUB 2-K 88 16 08 02 *	3 x GN 1/1, 200mm 975 x 510 210 mm	1 195 x 663 x 900	255	65	140

# Accessories:



Chapter 'Accessories', page 22

## 5.4 Bain-marie

### # Bain-marie table





BM 115 1/1 B

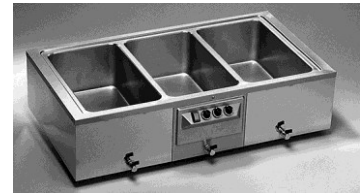

BM 115 2/1 B



BM 115 3/1 B

Type / Order no.:	Type	Outer dimensions of lid Outer dimensions with switch panel and connection cable L x W x H [mm]	Connected load [W]		
<b>Only wet-heated, water bain-marie.</b>					
BM 115 1/1 B 87 03 02 01	1x heated well, drawn-in. Without ridge edge. Niche width with lowered installation min. 660 mm	360 x 564 x 290 360 x 640 x 290	765	10.5	—
BM 115 2/1 B 87 03 02 02	2x heated wells, welded-in. With continuous ridge edge. Niche width for lowered installation min. 710 mm	753 x 614 x 290 753 x 690 x 290	1 530	17	—
BM 115 3/1 B 87 03 02 03	3x heated wells, welded-in. With continuous ridge edge. Niche width for lowered installation min. 710 mm	1 122 x 614 x 290 1 122 x 690 x 290	2 295	24	—

### # Accessories:



Chapter 'Accessories', page 22

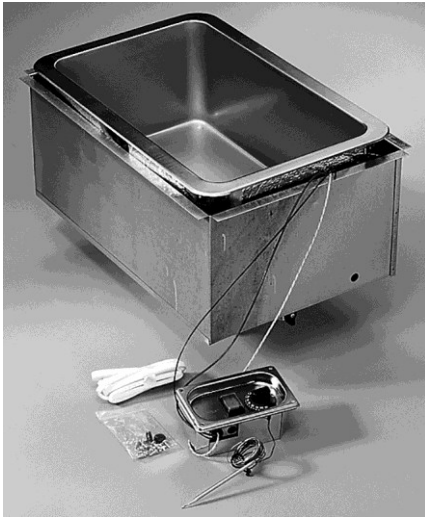

# Bain-marie for installation and welding in



... for installation  
The temperature on the outside of the housing is max. 55°C.



... for welding in

Type / Order no.:	Type	# Outer dimensions # Outer dimensions to lower edge of discharge tap # Table top cutout # Switchbox cutout # Stainless steel lid cutout L x W x H [mm]	Connected load [W]		
<b>Only wet heated. Water bain-marie.</b>					
BM 312 1/1 87 01 02 01	For installation Heated well completely insulated With insulated panelling/with discharge tap 410 x 609 x 242 mm (dimension with panelling)	370 x 574 x 228 370 x 574 x 326 356 x 556, R50 152 x 85 # ---	765	7.5	—
BM 313 1/1 87 01 02 02	For installation Heated well completely insulated Without insulation housing/with discharge tap	370 x 574 x 228 370 x 574 x 326 356 x 556, R50 152 x 85 # ---	765	6	—
BM 311 1/1 B 87 02 02 01	For welding in	345 x 549 x 227 345 x 549 x 326 # --- # --- 312 x 514, R32	765	6.5	—
BM 311 2/1 W 87 02 02 02	For welding in	669 x 549 x 231 345 x 549 x 392 # --- # --- 634 x 514, R32	1 530	8.5	—

BM 311 3/1 W 87 02 02 03	For welding in	994 x 549 x 231 994 x 549 x 392 # --- # --- 959 x 514, R32	2 295	10.5	—
-----------------------------	----------------	--	-------	------	---



See separately supplied installation instructions.

**# Accessories:**





Chapter 'Accessories', page 22

**# Bain-Marie 4.0**

With SWISS-PLY-PLATE and cooking function



Bain-Marie 4.0 — Cooking, keeping warm and dispensing in one appliance

Type / Order no.:	Type	Outer dimensions L x W x H [mm]	Connected load [W]		
----------------------	------	------------------------------------	-----------------------	---	---

Only wet-heated. **Water bain-marie.** For GN containers 1/1 200 mm max. Heat output up to **+200 °C**.  
 Digital control and temperature display.  
 Can be used as table-top appliance or niche solution.  
 SWISS-PLY-PLATE produces a 10-fold higher thermal conductivity, so that the desired temperature is reached more quickly.  
 Compatible with the **gastronorm360** range.

Bain-Marie 4.0 on request	For installation Heated well completely insulated With insulated panelling/with discharge tap 410 x 609 x 242 mm (dimension with panelling)	370 x 574 x 228	1 600	9	—
------------------------------	---	-----------------	-------	---	---



See separately supplied installation instructions.

### 6 Facts from delivery to the first cleaning

This chapter describes the measures to be taken before use.

#### # Check/handle transport damage

- Immediately after delivery, visually check the appliance for any transport damage.
- Document any potential transport damage on the consignment note in the presence of the haulage contractor. Have the damage confirmed by the haulage contractor (with signature).
- Decide if you wish to keep the appliance and report the defect using the consignment note, or if you wish to reject the appliance.

■ By following this procedure you will ensure proper claim settlement.

#### # Unpack

- Open the transport packaging at the positions provided for this purpose. Do not tear or cut.
- Remove any packaging remnants.

#### # Unload device



Transport with high physical demands should be avoided where possible, as the risk of an accident or injury is higher.

Lift / deposit a heavy load evenly with your knees bent and your upper body straight and upright. Your feet should be at least hip-width apart and your abdominal muscles braced. Breathe out. Do not twist your spine.



#### CAUTION

- Transport the appliance horizontally, as in its working position.
- Do not use aids such as forklift trucks to unload and transport the appliance.

#### # First cleaning



#### CAUTION

Protective foils or heat-sensitive objects at/in the appliance might damage the appliance during heating.

- Ensure that there are no protective foils on the inside or outside of the appliance.

- Clean the appliance.



See 'Cleaning, Maintenance and Care', page 38

#### # Information about packaging material

- Dispose of the disposable packaging with respect for the environment.

## 7 Use

### 7.1 Safety information with regard to use

#### 7.1.1 Comply with the operational principles

- Inspect the appliance before using it every time - particularly the electric connector and the electric cable for any visible damage.
- Do not operate the appliance unsupervised. Keep unauthorised persons away from the appliance to avoid risks such as burns on hot surfaces or unauthorised tampering with the water drain OPEN/CLOSED.
- The doors are self-closing. Press the slider down to additionally secure the closed door if necessary.
- Only use in dry rooms in the building. Never pour water on to electrical components. Protection against penetrating moisture is required.
- Risk of burns and scalds when handling the hot **bain-marie**. Risk of burns on the version with heated compartment.  
Wear personal protective equipment i.e. protective gloves. Be careful.
- Front-cooking is only permitted with a sneeze guard.
- Only operate the appliance with adequate lighting.

#### 7.1.2 Avoid risks due to mobile appliance

- Disconnect the connection cable. Only transport the product on straight surfaces. Always secure the position with the 'parking brakes'. Wear safety shoes to avoid injuries. Remove accessories and transport them separately.
- Push the appliance using the pushing handle;  
This will also give you a better overview and allow direct access to the 'castors with parking brake'.
- Keep the door and the sliding lid closed during transport.
- Only transport unit on a straight surface. Do not transport on a sloping surface.



- **CAUTION**  
Do not use this appliance on poor floor conditions.

#### 7.1.3 Prevent risks due to electricity

- Connect the appliance to a socket with a pre-switched FI circuit breaker (RCD) with a tripping current of 30 mA.
- The socket outlet must be easily accessible so that the unit can be disconnected from power supply at any time.

### 7.1.4 Prevent risk of slipping /falling



#### ⚠ Risk of slipping and falling due to human error

On the version with a sliding or hinged lid steam may condense on the inside of the lid, so that condensation drips onto the floor.

Hot water can run out of the discharge tap and cause **scalds**.

- **Bain-marie** with a GN container and matching lid.
- Before closing the sliding or hinged lid, seal the GN container with the lid.
- Open the sliding lid **in two stages**.
- Pay attention to the position on the water drain "OPEN – CLOSED". Keep unauthorised persons away.

Transporting

Sliding lid in heating position

Opened for serving food

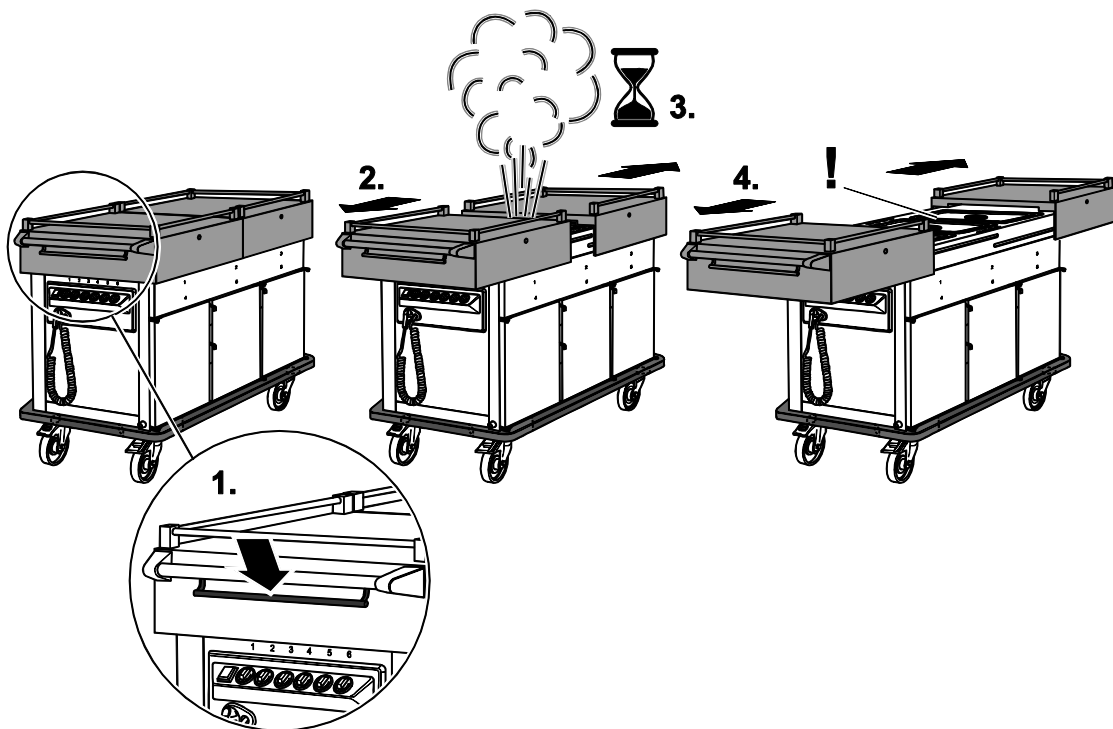

Open the sliding lid **in two stages**. To do this:

- Press the frame down to open; pull the handle and release the frame.
  - The sliding lid locks. Steam escapes from the opening between the sliding lids.
- Repeat this with the other sliding lid.
- Wait until the intensively rising steam has escaped.
- Press the frame down to open the sliding lid completely. Pull the handle to move the sliding lid into the end position.



Also note:

- Open the sliding or hinged lid during heating as a **water bain-marie**.
- Wipe the underside of the sliding lid or inner side of the hinged lid dry if necessary with an absorbent non-scratch cloth.



- Wipe moisture up immediately with an absorbent non-scratch cloth.
- Wipe the underside of the sliding lid or inner side of the hinged lid dry if necessary with an absorbent non-scratch cloth.

Examples

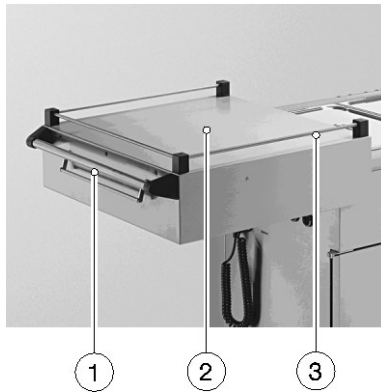

Sliding lid opened



Hinged lid opened

- 1 Notched lever → releases the sliding lid from the latched safety position
- 2 Sliding lid

## 7.2 Instructions for use of the bain-marie

- **Bain-marie** on **delivery trolleys** and **food transport trolleys** can be used as a **dry bain-marie** or as a **water bain-marie**.
- **Bain-marie** as table-top or built-in version is a **water bain-marie**.
- **Bain-Marie 4.0** as a **water bain-marie**.
- Use GN container with a matching lid.
- Only transport hot liquids in closed container with press-in lid.



110 °C

### **WARNING**

When changing over GN containers or working in the area of the hot bain-marie there is a risk of injuring oneself on the hot surfaces, which can be up to 110 °C, or scalding oneself on hot water or steam.



Risk of scalding due to pouring water into an overheated bain-marie after water loss, for example.

- Wear protective gloves in the area of the hot bain-marie.
- In the event of water loss in the **water bain-marie**, allow the appliance to cool down first. Only then should you fill with water.

### # Water bain-marie ...

A bain-marie which is only intended to be '**wet-heated**' should only ever be wet-heated.

- Make sure that the drain tap is closed. The drain tap is on the bottom.
- Pour **approx. 2 cm water** into the bain-marie.
  - █ More water would only waste unnecessary energy and impede heating.

### # Dry bain-marie ...

A bain-marie which is only intended to be '**dry-heated**' should only ever be dry-heated.



### **User tip**

**Dry bain-marie** with radiant heat.

- A heating-up time of around 5 minutes is adequate.
  - █ This saves on energy and electricity costs.
  - █ Less steam is generated, which is more pleasant in smaller rooms.

### # Heating-up time ...

- Switch the device ON at the 'rocker switch with indicator light'.
  - Green indicator light illuminates.
- Set the desired power on the 'heat control dial'.
  - Approx. 5 minutes' heating-up time are sufficient for dry heating.
  - Approx 45 minutes' heating-up time are needed for wet heating.
  - When heating without the lid, the heating-up time will be longer.

### # After use

- Let the **bain-marie** cool down.
  - Approx. **20 minutes'** cooling down time are sufficient to avoid risks of burns and scalds.
- Drain the cooled water from the **bain-marie** through a floor drain.



*'Cleaning, Maintenance and Care', page 38*

### # Note on frames and GN containers with lids from Rieber

Frames for the division of wells, so that smaller containers, e.g. GN 1/4, can be used.



*Chapter 'Accessories', page 22*



### User tip

GN containers are standardised but do not generally fit into one another.

- Use GN containers with lids from Rieber.
  - This saves on energy and electricity costs.

## 7.3 Instructions for use of appliances with 'Refrigerated cupboard'

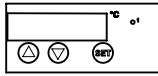

Adjustable from +2 °C to +10 °C.  
The chilling compartment is marked with the same symbol.

### **⚠ Comply with the HACCP regulations**

- Pre-chill the empty chilling compartment before use.
  - ▮ The pre-chilling time should be 30 minutes, with an empty compartment and normal ambient conditions.
- Only fill the appliance with adequately pre-chilled, packaged/wrapped food.
- Leave free space in the appliance. Due to the air convection and the filling state of the appliance, the ACTUAL temperature may deviate from the control temperature.
- **⚠ WARNING**  
Only introduce food pre-chilled to storage temperature. Only open the refrigerated compartment briefly and close it again immediately. Empty and clean the refrigerated compartment at least 1x daily. Do not use incorrectly for continuous cooling.

### **# Query set temperature**

- Press the SET button (3) to display the SET temperature.

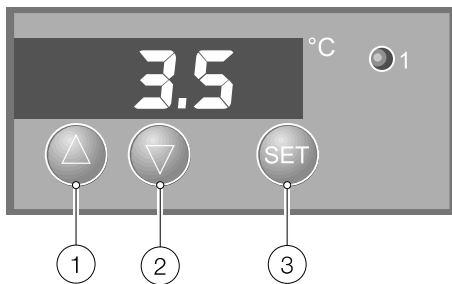

- 1 Arrow button: Increase temperature
- 2 Arrow button: Decrease temperature
- 3 SET button

### **# How to change the set temperature**

- To change the set temperature, keep the SET button pressed and use buttons (1) and (2) to edit the value.
  - ▮ The adjusted value is saved automatically.



### **User tip**

- Use Gastronorm containers and thermoplates® from Rieber.

---

## 7.4 Instructions for use of appliances with 'Heated cupboard'

---

### Comply with the HACCP regulations

- Heat up the appliance for keeping food warm before use.
- Only fill the appliance with adequately pre-heated, packaged/wrapped food.
- Leave free space in the appliance. Due to the air convection and the filling state of the appliance, the ACTUAL temperature may deviate from the control temperature.
- Wear personal protective equipment and protective gloves in order to avoid burns to the hands and arms.
- Empty and clean cupboard after use at least 1x daily.

### # Set desired temperature

Heating range, 3-stage      Approx. **+35 °C — 70 °C — 110 °C**

- Turn the rotary switch to the desired heat level.
  - The compartment is heated. The set temperature is reached after **around 20 minutes**.

## 7.5 Clean the appliance daily after use.

---

- Switch the appliance off. Pull out the electrical connection plug and place in the holder.
- Clean the appliance daily after use.



'Cleaning, Maintenance and Care', page 38

## 8 Cleaning, Maintenance and Care

This chapter will help you to meet the hygiene requirements. Before reading this section, please read through the "General safety instructions" section thoroughly first.

### 8.1 Safety information relating to cleaning, maintenance and care

---

#### Risk of burns, scalds and slipping

---



#### Risk of burns, scalds and slipping



**Risk of burning** hands and arms on hot parts such as the **bain-marie** and 'heated cupboard'.

**Risk of scalds** due to hot steam on the **bain-marie** and draining of hot water from the **bain-marie**.

- Drain the hot water from the **bain-marie** through a floor drain.
  - Allow the device to cool down.
  - Wear personal protective equipment, i.e. protective gloves and safety shoes.
- 

#### Avoid risks from electricity

---



#### WARNING

Danger of electric shock. Risk of death.



- Disconnect the appliance from the mains; disconnect the power supply unit.
  - Protect the appliance against moisture. Never direct a jet of water at electrical components such as heater, controller or ventilation grille.
  - Check the heating and connecting cable for any damage.
  - Do not use a steam cleaning unit to clean electrical appliances. Doing so may allow moisture to get into the electrical system and cause a short circuit. Do not expose to spray water. Wipe electrical parts with a moist cloth only and dry the surface using a dry cloth.
  - Have electrical appliances inspected by a qualified electrician **every six months**.<sup>1</sup>
- 

---

<sup>1</sup> Source: DGUV Regulation 3. Electrical Systems and Equipment

## 8.2 Cleaning agents for stainless steel

### # The following applies for all cleaning agents:

- Observe the instructions for use provided by the cleaning agent manufacturer.

### # Mechanical cleaners for stainless steel

Cleaning agent	Suitable
Brush products	Brushes with natural or synthetic bristles
Textiles	Textile material comprising natural and chemical cleaning fibres and textile fabrics (knitted and woven fabric, cleaning cloths, floor cloth, fringed material, fleece). Microfibre cleaning textiles are ideal for removing finger marks from stainless steel surfaces.
Synthetic fleece	Without abrasives. Mainly produced in the colours white, beige, yellow.
Other	Natural leather (chamois), synthetic leather, synthetic fleece, sponges, sponge cloths

### # Chemical cleaners for stainless steel

Cleaning agent	Areas of application
All-purpose cleaners	Particularly for lighter grease stains.
Neutral cleaners	For surfaces soiled with grease and oil (fingerprints); also suitable as a dishwashing detergent.
Alcohol cleaners	As all-purpose cleaner
Alkaline cleaners	Especially for heavy grease and oil stains (dried-in oils). Observe the manufacturer's dosage instructions.
Solvent cleaners	Depending on the type, particularly good for the removal of grease, oil, wax, tar, adhesives, paints and lacquers. Not suitable for plastics.
Disinfectant cleaners	Effect on pathogenic germs differs depending on active disinfectant ingredient. Long-term exposure to sodium hypochlorite can cause damage to the material. It should not be used if possible. Products should be used, which are specified in the list of the German Society of Hygiene and Microbiology (DHGM).

### # Note on care products for stainless steel



#### User tip

- We recommend **Rieber cleaning agent for stainless steel** for cleaning stainless steel.

■ It is especially thorough yet gentle cleaner, produces a dazzling shine, and cleans and protects in one.

Order no.: 72 10 24 08

## 8.3 Choose the correct cleaning method

---



### CAUTION

Incorrect cleaning can damage the surface or even destroy the appliance. Please note:

- Do not scratch the surface with sharp-edged objects. Do not use any abrasive or aggressive cleaning agents, such as oven spray or a sponge with an abrasive surface.
- Remove dirt with cleaning and care products that are suitable for stainless steel.
- Do not mix standard cleaning agents; do not produce your own cleaning agent.
- Do not use steel wool or steel brushes.
- Avoid extended exposure of stainless steel to liquid containing salt, as this can lead to surface discolouration and corrosion.
- Avoid direct, extended contact of stainless steel with corroding iron parts, e.g. cast iron pans or steel kitchen sponges.

#### # Clean and service stainless steel parts

→ Relates to housing, **bain-marie**, heated cupboard, refrigerated cupboard, door



### CAUTION

Incorrect cleaning can cause damage to the surface.

- Clean the appliance with a **hot, mild detergent diluted in water**. After cleaning, rub surfaces dry with a **soft cloth**.

#### # Clean and service plastic parts

→ Relates to castors, operator's controls such as switches and control unit, door seal











### CAUTION

Incorrect cleaning can cause damage to the surface.

- Clean the appliance with a **hot, mild detergent diluted in water**. After cleaning, rub surfaces dry with a **soft cloth**.



## 8.4 Overview of intervals

Interval	Activity to be performed	Page
Daily after use	Drain <b>water bain-marie</b>	 <a href="#">Page 42</a>
	Clean <b>bain-marie</b>	 <a href="#">Page 42</a>
	Defrost and clean 'refrigerated cupboard'	 <a href="#">Page 43</a>
	Clean 'heated cupboard'	 <a href="#">Page 43</a>
If required	Clean castors	 <a href="#">Page 43</a>
	Remove fluff from ventilation grille of machine compartment.	 <a href="#">Page 43</a>
	Descale <b>bain-marie</b>	 <a href="#">Page 44</a>
Every 180 working days or 6 months	Have electrical system /control checked.	 <a href="#">Page 38</a>

## 8.5 Drain water bain-marie

---

### # Example: Food transport trolley

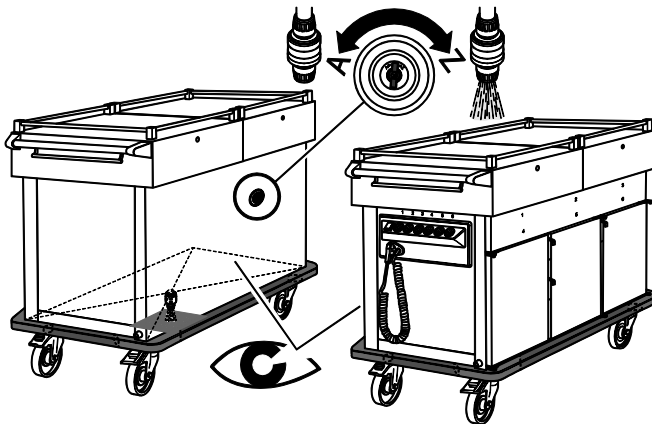

- Drain the water.  
To open the water drain, turn controller to position **A = OPEN**.  
To close the water drain, turn controller to position **Z = CLOSED**.

### # Example: Bain-marie

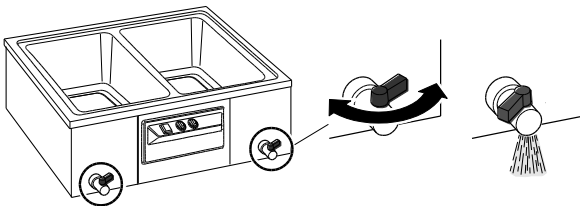

### # Example: Delivery trolley

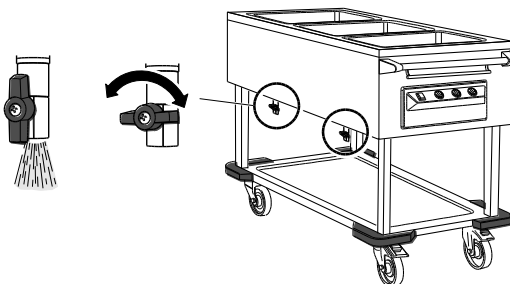

## 8.6 Clean the bain-marie

---

- Wipe out the well with a damp cloth to pre-clean if necessary.
- Clean the bain-marie and stainless steel parts with a **mild detergent diluted in hot water**.
- Rinse with clear water.
- After cleaning, rub the surfaces dry with a **soft cloth**.

## 8.7 'Refrigerated cupboard'

### # Clean daily after use

- Switch off the appliance electrically and remove the mains plug.
- Empty the compartment.
- Allow to defrost.
- Clean with a **mild detergent diluted in hot water**. After cleaning, rub the surfaces dry with a **soft cloth**.
  
-  **Fire hazard risks**  
Clean fluff from the ventilation area **at least 1x monthly**.  
Use a vacuum cleaner to extract fluff from the ventilation grille or remove the fluff with a cloth or brush. Then rub with a slightly damp cloth.

## 8.8 'Heated cupboard'

### # Clean daily after use

-  **WARNING**  
**Risk of burns to hands and arms.** Allow the cupboard to cool down.
- Switch off the appliance electrically and remove the mains plug.
- Allow the cupboard to cool down.
- Clean with a **hot, mild detergent diluted in water**. After cleaning, rub the surfaces dry with a **soft cloth**.

## 8.9 Clean castors



### CAUTION

Cleaning the castors incorrectly can damage them.

- Clean the castors with mild washing up detergent diluted in hot water. After cleaning, rub surfaces dry with a soft cloth.

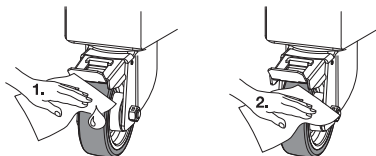

## 8.10 Descale the bain-marie if necessary

---



### User tip

Sure signs of calcification are: visible limescale, extended processing time, increased noise generation, intense steam generation.

- It is best to descale the appliance before thorough cleaning.



*Chapter 'Drain water bain-marie', page 42*

- Descale the appliance in accordance with the descaler manufacturer's instructions.
- Finally, clean the **bain-marie** with clear water and an absorbent non-scratch cloth. Repeat until all residues of the descaler are safely removed.

## 8.11 Keep ready for next use in dry condition

---

- Dry the inside of the appliance and leave the door open until the residual moisture has dried off.
- Store appliance at room temperature.

## 9 Troubleshooting – What now?

### 9.1 Notes on troubleshooting



#### **⚠ WARNING**

Danger of electric shock. Dangerous electrical voltage.

- Disconnect the connecting plug on the unit before starting repair work.
- Have all electrical repairs carried out by an authorised electrician only.

Any repairs during warranty period may only be carried out by the manufacturer's service department of Rieber. Please contact the Rieber service department.

Work on the cooling unit should only be carried out by authorised skilled personnel like a **refrigeration specialist** or a member of the Rieber Customer Service.

<b>Fault</b>	<b>Possible cause</b>	<b>Rectification</b>
'Rocker switch with indicator light' does not illuminate	Device not connected correctly Power supply interrupted Overheating protection has tripped	<ul style="list-style-type: none"> <li>➤ Check electrical connection                             <ul style="list-style-type: none"> <li># User</li> </ul> </li> <li>➤ Repair                             <ul style="list-style-type: none"> <li># Qualified electrician</li> </ul> </li> </ul>
Temperature not controllable (too low / high)	Temperature controller defective	<ul style="list-style-type: none"> <li>➤ Disconnect connecting plug and lock appliance.</li> <li>➤ Repair                             <ul style="list-style-type: none"> <li># Qualified electrician</li> </ul> </li> </ul>
Appliance does not heat up	Plug / spiral cable / rocker switch / heating system defective	<ul style="list-style-type: none"> <li>➤ Repair                             <ul style="list-style-type: none"> <li># Qualified electrician</li> </ul> </li> </ul>
Caster / 'caster with parking brake' blocked or defective	Fault or damage	<ul style="list-style-type: none"> <li>➤ Remove blocking foreign bodies; replace parts if necessary                             <ul style="list-style-type: none"> <li># Operating staff</li> </ul> </li> </ul>

### Customer service, spare parts



#### **IMPORTANT**

Customer service needs information about the type and number of your appliance.

- If you have a fault you cannot remedy yourself, please get in touch with your Rieber partner or Rieber central customer services.

## 9.2 Disposing of your product

---



Your appliance is made of high-quality material which can be reused / recycled. For disposal, disconnect the appliance from mains supply. Unplug the mains plug. Cut off the cable directly at the casing. Dispose of this appliance properly via your local disposal facility.



#### **Risk of suffocation**

Persons with limited sensory and mental ability might get locked in.

- When disposing of the unit, destroy the door lock.
-

## 10 Warranty and liability

Manufacturer liability and warranty shall no longer apply if

- you do not follow the information and instructions in this user guide,
- do not use the device as it is intended,



See chapter "*Designated purpose of use*"

- make conversions or functional modifications,
- do not use original spare parts.

The "Sales and delivery terms and conditions" of Rieber GmbH & Co. KG shall apply for all warranty claims made against the manufacturer. For instance, any repairs and/or overhaul during the warranty period may only be performed by the manufacturer's service department of Rieber, failing which any claims hereof may be voided. Please contact the manufacturer's service department at Rieber.

The following wearing parts are not included in the warranty:

- Caster
- Caster with parking brake
- Corner bumper

## 11 Excerpt from EC Declarations of Conformity

### **EC Declaration of Conformity according to EC Machinery Directive 2006/42/EC**

The company Rieber GmbH & Co. KG herewith declares that the products

- Food transport trolley with cupboard with adjustable cooling
- Delivery trolley with refrigerated well with adjustable cooling

comply with the basic requirements of the EC Machinery Directive 2006/42/EC, Appendix II A, harmonised standards (DIN EN ISO 12100: Safety of Machinery — General principles for design — Risk assessment and risk minimisation).

### **EC Declaration of Conformity**

#### **Low Voltage Directive 2014/35/EU and EMC Directive 2014/30/EU**

The company Rieber GmbH & Co. KG herewith declares that the products

- Food transport trolley,
- Delivery trolley and
- Bain-marie in its respective heated version

comply with the basic requirements of the European Directive 2014/35/EU and 2014/30/EU.

If required, a copy of the EC Declaration of Conformity can be obtained from our sales team.

## 12 Manufacturer's address

Rieber GmbH & Co. KG  
Hoffmannstraße 44  
D 72770 Reutlingen, Germany  
Phone +49 (0) 7121 518-0  
FAX +49 (0) 7121 518-302  
Email [info@rieber.de](mailto:info@rieber.de)  
[www.rieber.de](http://www.rieber.de)