



# varithek<sup>®</sup> 2.0

## With Ceran<sup>®</sup> glass hob

1/1-ch-800	For hot holding of food
1/1-ck-2200	for keeping food warm, automatic regeneration, cooking
1/1-ck-2800	for keeping food warm, cooking
1/1-ck-3400-2Z-o	for keeping food warm, cooking with 2 heat zones



## With induction hob

1/1-ik-3500	for keeping food warm, cooking
1/1-ik-3500-o	for keeping food warm, cooking
1/1-ik-3600-2Z-□	for keeping food warm, cooking

## With stainless steel grill area

1/1-gp-3400-SP	for grilling
----------------	--------------

## With stainless steel cooling surface

1/1-hp-SP	for keeping food warm or cold
1/1-hp-SP-E	for keeping food warm or cold, for installation

## Units of size 1/1, width 325 mm



Observe the operating instructions

Translation of the Original Operating Instructions

DOWNLOAD: USER MANUAL

QR code on type plate



EN

**Rieber Professional.** Our solutions provide quality, safety and, in particular, a high level of energy efficiency and cost effectiveness.

**CHECK HACCP** – In the area of HACCP documentation the CHECK CLOUD platform offers the CHECK HACCP digital system, for simple, safe and transparent temperature detection.

In addition to this, further digital features are possible in the areas of hygiene and service management. The automated digital answer to the analogue paper trail.



## Contents

<b>1</b>	<b>Revision Index</b> .....	<b>4</b>
<b>2</b>	<b>Important Information</b> .....	<b>4</b>
2.1	Using this guide .....	4
2.2	Representation conventions in the text .....	5
2.3	Structure of safety instructions .....	5
2.4	Abbreviations used in the type designation .....	5
<b>3</b>	<b>Description of device</b> .....	<b>6</b>
3.1	Type overview.....	6
3.2	Identification of components .....	7
3.2.1	Types ch and ck.....	7
3.2.2	Type gp.....	8
3.2.3	Types ik .....	8
3.2.4	Types for keeping food warm or cold .....	9
3.3	Technical data .....	11
3.4	Accessories and their use.....	12
3.4.1	thermoplate® .....	12
3.4.2	varithek® GN-port .....	13
3.4.3	varithek® table-top system modules.....	13
3.4.4	varithek® built-in system modules.....	14
<b>4</b>	<b>Purpose</b> .....	<b>15</b>
4.1	Generally, the following are intended uses for the product.....	15
4.2	Prevent any potential misuse .....	15
4.3	Special intended use for appliances with a Ceran® glass surface.....	16
4.4	Special intended use for appliances with an induction hob .....	16
4.5	Special intended use for appliances with a stainless steel grill area .....	16
4.6	Special intended use for appliances with a stainless steel cooling surface .....	16
<b>5</b>	<b>General Safety Instructions</b> .....	<b>17</b>
5.1	Personnel qualification requirements .....	19
5.2	Provision of protective equipment for personnel .....	20
5.3	Appliance-specific safety instructions.....	20
5.3.1	Safety and monitoring devices .....	20
5.3.2	Risks from hot surfaces, burns and explosion .....	21
5.3.3	Dangers due to unexpected heating of objects as a result of induction .....	21
5.3.4	Danger for persons with pacemakers due to induction .....	22
5.3.5	Danger of electric shock.....	22

5.3.6	Danger of cuts from damaged Ceran® glass surface .....	23
5.3.7	Note the product identification and ensure its preservation .....	23
5.4	Information about regulations to be followed .....	23
5.5	What to do in an emergency .....	24
<b>6</b>	<b>Before First Use.....</b>	<b>24</b>
<b>7</b>	<b>Safety instructions for commissioning /recommissioning.....</b>	<b>25</b>
<b>8</b>	<b>Use.....</b>	<b>26</b>
8.1	Safety information with regard to use .....	26
8.2	General mode of operation.....	27
8.2.1	Start process .....	27
8.2.2	Stop process .....	27
8.2.3	Switch appliance off .....	28
8.3	ch-800.....	28
8.4	ck-2200.....	28
8.5	ck-2800.....	30
8.6	ck-3400-2Z-o .....	31
8.7	ik-3500, ik-3500-o .....	32
8.8	ik-3600-2Z-□.....	33
8.8.1	Overview of functions .....	33
8.8.2	Intended use of ik-3600-2Z-□.....	35
8.8.3	Instructions for use.....	35
8.9	gp-3400-SP .....	36
8.10	Accessories and their use .....	36
<b>9</b>	<b>Cleaning, maintenance and care.....</b>	<b>37</b>
9.1	Safety information relating to cleaning, maintenance and care .....	37
9.2	Choose the correct cleaning method .....	38
9.3	Clean and service stainless steel parts .....	38
9.4	Clean and service plastic parts .....	39
9.5	Clean grease filter, grease drip tray .....	39
9.6	Clean the ventilation grille .....	39
9.7	hp-SP, hp-SP-E .....	40
9.8	Ensure preservation of the product identification.....	40
9.9	Keep ready for next use in dry condition .....	40
<b>10</b>	<b>Troubleshooting .....</b>	<b>41</b>
<b>11</b>	<b>Warranty and liability .....</b>	<b>42</b>
<b>12</b>	<b>Excerpt from EC Declarations of Conformity.....</b>	<b>42</b>
<b>13</b>	<b>Index.....</b>	<b>43</b>
<b>14</b>	<b>Manufacturer's address.....</b>	<b>43</b>

# 1 Revision Index

Revision	Change
2011-03-16	First issue
2011-05-02	Declaration of conformity
2011-07-24	Safety instructions supplemented: Chap. 4.2; Chap. 5.2, Chap. 7.1, Chap. 8.1
2012-09-11	Safety instructions supplemented; Comprehensibility improved
2012-10-31	Pages 6, 23, 24, 29
2012-12-12	Page 9
2013-11-07	Potential equalisation, product identification
2014-04-25	KP-220; Register, product identification, K POT calibration
2017-02-23	TÜV, hot/cold appliance, built-in appliance
2019-04-01	Type designation

# 2 Important Information

## 2.1 Using this guide

This guide contains important information about how you can use the appliance safely and correctly.



- ▶ Read the operating instructions before first using the product.
- ▶ Keep this guide in a safe place and pass it onto the next owner should you wish to part with the product.

Our customers often express the wish to have one compact guide instead of a number of different guides for these product variants, which have similar functions.

If there are any shortcomings in your opinion, please do not hesitate to let us know. With your help, we will try to become even better.

Please add your notes here ☺

---

---

---

---

---

## 2.2 Representation conventions in the text

- Lists are represented in this way.
- Instructions on certain actions are represented in this way.
- The result of the action is represented in this way.



See '...' , cross-references are represented in this way.



### CAUTION

indicates potential damage to property without any personal injury.  
Failure to follow these instructions may cause damage to property.



### User tip

▶ Useful information or tip

## 2.3 Structure of safety instructions

The signal words DANGER - WARNING - CAUTION classify the possible degree of risk of bodily injury in an actual situation. You can avoid injury by complying with the behavioural rules provided.

The warning triangle symbol indicates a "General Danger".



### DANGER

indicates **imminent danger**.

Failure to follow these warning instructions will result in serious bodily injury or even death.



### WARNING

indicates a **potentially hazardous situation**.

Failure to follow these warning instructions **may cause serious bodily injury or even death**.



### CAUTION

indicates a **potentially harmful situation**.

Failure to follow these warnings **may cause minor bodily injury**.

## 2.4 Abbreviations used in the type designation









c: ceran, i: induction, h: heating surface, k: hob, w: wok, Z: area,

o: round, □: angular, SP: SWISS-PLY, hp: hybrid plate, gp: grill plate,

pf: pasta/fritteuse, F: front flap

### 3 Description of device

#### 3.1 Type overview

	<b>varithek® 2.0</b>	<b>Notes:</b>
	1/1-ch-800	Ceran® glass surface, 800 W, 1/1 flat
	1/1-ck-2200	Ceran® glass surface
	1/1-ck-2800	Ceran® glass surface, 1/1 flat
	1/1-ck-3400-2Z-o	Ceran® glass surface, 2x round
	1/1-ik-3500	Ceran® glass surface with induction hob, 1/1 flat
	1/1-ik-3500-o	Ceran® glass surface with induction hob, 1x round
	1/1-ik-3600-2Z-□	Ceran® glass surface with 2 induction hobs
	1/1-gp-3400-SP	Stainless steel plate, 1/1 flat

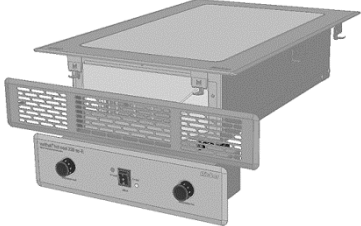
	<p>1/1-hp-SP</p>	<p>Plate comprising multi-layer material, 1/1 flat, keeping warm and chilling operating modes</p>
	<p>1/1-hp-SP-E</p>	<p>Plate comprising multi-layer material, 1/1 flat, keeping warm and chilling operating modes; analog control; For installation</p>

### 3.2 Identification of components

All parts are named here to facilitate further understanding of the manual.

#### 3.2.1 Types ch and ck



- 1 Ceran® glass surface
- 2 Lead
- 3 Indicator light for outer front heating surface, lights up YELLOW
- 4 Retractable and continuously variable power regulator and ON/OFF switch



- 5 Indicator light for 'Switched ON/OFF' operating status, which lights up GREEN; the corresponding power regulator is located on the right
- 6 Indicator light for 'hot surface' residual heat indicator, lights up RED, front and rear heating surface

### 3.2.2 Type gp



- |   |  |   |   |
|---|--|---|---|
| 1 | Stainless steel heating surface  | 4 | Retractable and continuously variable power regulator and ON/OFF switch |
| 2 | Lead   | 5 | Grease drip tray  |
| 3 | Indicator light for 'Switched ON/OFF' operating status, which lights up GREEN during heating | 6 | Grease drain  |

### 3.2.3 Types ik

Induction hob



- |   |   |   |   |
|---|---|---|---|
| 1 | Induction hob /Ceran® glass surface                     | 5 | Retractable and continuously variable power regulator and ON/OFF switch |
| 2 | Lead  | 6 | Grease filter   |
| 3 | Indicator light   |   |   |
| 4 | Indicator light for 'Switched ON/OFF' operating status' |   |   |



**i** The **indicator light** for the **operating status** lights up GREEN, when the appliance is switched on.

**i** The **operation indicator light** illuminates GREEN, when the inductive mode is activated or a metal pan is on the heating surface.



7 Retractable and continuously variable power regulator, **front** heating surface

9 ON/OFF switch

8 Retractable and continuously variable power regulator, **rear** heating surface

### 3.2.4 Types for keeping food warm or cold



1 Surface for keeping food warm or cool  
 2 Lead  
 3 Toggle switch, 3-stage. Switched OFF in position '0', pressed up switches the chilling function on, pressed down switches the keep-warm function on

4 LED lights up green when the chilling function is switched on  
 5 LED lights up yellow when the keep-warm function is switched on  
 6 Retractable and continuously variable power regulator from 0 to 9 for both the cooling function and the keep-warm function

1/1-hp-SP

For keeping food warm or cold

500 W

Width 325 mm  
 Depth 642 mm  
 Height 143 mm

Weight 14.1 kg

The appliance starts immediately from cold to hot. Up to around +120 °C in keep-warm mode.

From hot to cold, the appliance starts when the multi-layer plate has cooled down to around 40 °C. To around -7 °C in cooling mode.

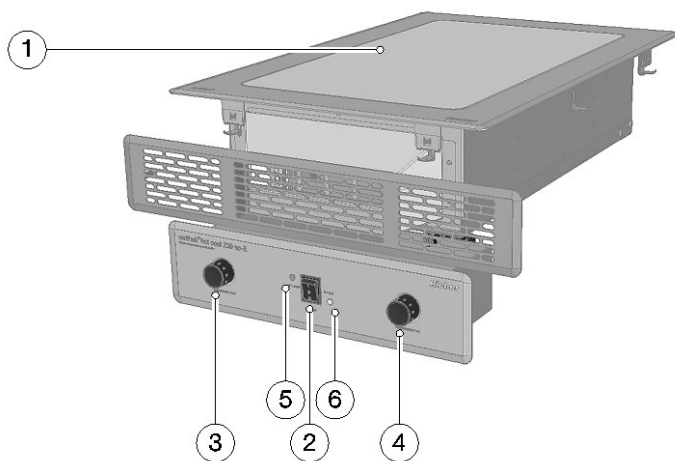

1/1-hp-SP-E

For keeping food warm or cold

500 W

Function field:  
Width 398 mm  
Depth 603 mm  
Height 139 mm

Control:  
Width 388 mm  
Depth 142 mm  
Height 100 mm

Weight 16.1 kg

The appliance starts immediately from cold to hot. Up to around +120 °C in keep-warm mode.

From hot to cold, the appliance starts when the multi-layer plate has cooled down to around 40 °C. To around -7 °C in cooling mode.

- |   |  |
|---|--|
| <p>1 Surface for keeping food warm or cool</p> <p>2 Toggle switch, 3-stage.<br/>Switched OFF in position '0',<br/><br/>pressed up switches the chilling function on,<br/><br/>pressed down switches the keep-warm function on</p> | <p>3 Retractable and continuously variable power regulator from 0 to 9 for the keep-warm function</p> <p>4 Retractable and continuously variable power regulator from 0 to 9 for the chilling function</p> <p>5 LED lights up green when the chilling function is switched on</p> <p>6 LED lights up yellow when the keep-warm function is switched on</p> |
|---|--|

### 3.3 Technical data

	ch-800	ck-2200 ck-2800 ck-3400-2Z-o	gp-3400-SP	ik-3500 ik-3500-o	ik-3600-2Z-□	hp-SP 
Connected value [W]	800	2 200 2 800 3 400	3 400 2 500	3 500	3 600	220
Power generation	Electric hob	Electric hob	Grill	Induction	Induction	Refrigeration capacity 180 <sup>1</sup> watts at VT - 10 °C, refrigerant R 134a
Material						
Work surface	Ceran® glass surface	Ceran® glass surface	Stainless steel	Ceran® glass surface	Ceran® glass surface	SWISS-PLY® multi-layer material
Housing	Stainless steel					
External dimensions [mm]						
Width	325	325	325	325	325	325
Depth	620	620	620 / 642	642	642	642
Height	62	78	143	140	78	143
Weight [kg]	6.5	6.5 / 7.0	13	13	9.2	14.1
Ambient temperature	+5 °C to +40 °C					
Load-bearing capacity of installation area [kg]	40 kg					
Minimum distance from walls	20 cm					
Protection class	IPX4 as per EN 60529 protection against splashing. For installation outdoors a canopy or protection from penetrating moisture is required.					
Rated voltage / mains frequency	1N AC 230 V 50 / 60 Hz					
Length of connection cable:	0.8 m or 2.5 m as per the purchase order					

Hobs can be distinguished according to the type of heat generation:

- Electric hob: → The heat is generated within the hob with electric heating elements.
- Induction hob: → The hob generates an alternating magnetic field, whose energy heats the base of the pot.

The appliances are equivalent to 1/1 Gastronorm in size.

<sup>1</sup>Temperature adjustable from around -7 °C to +12 °C at a room temperature of around 20 °C.



Equipotential bonding on the underside of the appliance. This protective measure serves for additional safety. Standard-compliant implementation with subsequent inspection of the system is carried out by a qualified electrician.



IEC 60364-5-54:2011; for Germany DIN VDE 0100:540:2012-06

For detailed information on dimensions, order number, accessories, circuit diagrams, spare and wearing parts:



[See catalogue/brochure](#)

## 3.4 Accessories and their use

---



### User tip

With the right accessories, **varithek® 2.0** is energy-saving, and the appliance can be used for a wider range of applications.

- ▶ Use accessories from Rieber.

### 3.4.1 thermoplate®



### User tip

**thermoplate®** is cookware in GN format; suitable for both cooling and cooking without having to transfer.

**varithek® 2.0** is optimally designed for the use of **thermoplate®**.

- ▶ Use the **thermoplate®** with a lid.
  - This will save time and energy.

### 3.4.2 varithek® GN-port

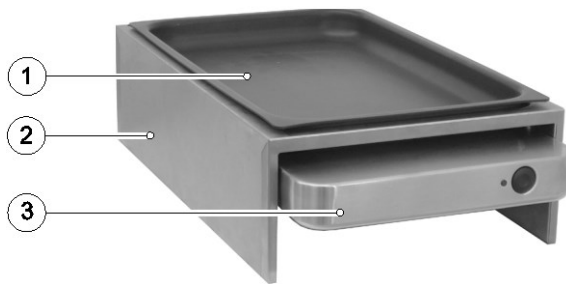

- 1 thermoplate®
- 2 varithek® GN-port
- 3 varithek® 2.0

- **thermoplate®** directly on the Ceran® glass surface of the varithek® 2.0 appliance, otherwise the appliance could overheat and be damaged. Does not apply for type 'ch-800'.

### 3.4.3 varithek® table-top system modules

- **Place thermoplate®** directly on the Ceran® glass surface of the **varithek® 2.0** appliance, otherwise the appliance could overheat and be damaged. Does not apply for type 'ch-800'.



- 1 thermoplate®
- 2 varithek® 2.0 Ceran hob
- 3 varithek® table-top system module

- Stainless steel, double-walled, with base. Front flap double-folding; or without flap.
- Suitable for use on a table or in a placement niche.
  - This offers greater safety for use on the table in front of the guest.
- Suitable for integrating different **varithek®** functional elements. The rack height can be selected by way of the beading on the inside.
- **ATTENTION Do not place varithek® 2.0** on top of the frame of a **varithek®** system module. Only insert as shown in the images.

### 3.4.4 varithek® built-in system modules

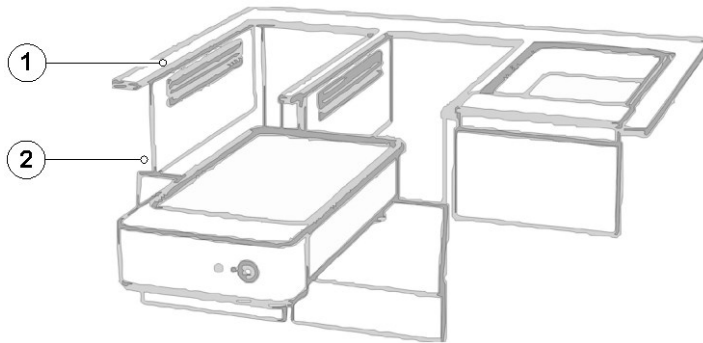

- 1 Upper frame
- 2 **varithek® V-EST built-in system module**

- For fixed installation in a suitable furniture unit.
- For integrating different **varithek®** function elements.

- **⚠ WARNING** Risk of burns! Risk of overheating. Always leave the system module flap open on an appliance with inductive heating.
- **ATTENTION** Place **thermoplate®** directly on the Ceran® glass surface of the **varithek® 2.0** appliance, otherwise the appliance could overheat and be damaged. Does not apply for type 'ch-800'.
- **ATTENTION** Do not insert **varithek® 2.0** on the upper frame of a **varithek® system module**. Only insert as shown in the image below.

## 4 Purpose

This chapter describes the intended use and contains warnings against misuse, for your safety.

### 4.1 Generally, the following are intended uses for the product

- For system catering, catering, hotels and restaurants and school cafeterias.
- Suitable for use as a table-top unit.  
Designed for integration in the **varithek® GN port**.  
Designed for integration in the **varithek® table-top system module**.  
Designed for integration in the **varithek® built-in system module**.



*See "Accessories and their use", page 12*

- To prevent persons from burning themselves on hot surfaces, use of the product in public/for self-service should only be allowed under constant supervision.
- Wear personnel protective equipment such as protective gloves to avoid burns to your hands and arms when close to hot parts such as the hob, containers and food.
- For use by adults only.
- Only operate the appliance on a disconnectable mains socket.
- Connect a residual current operated device with a tripping current of 30 mA in series on site.
- Equipotential bonding must be carried out by a qualified electrician.
- The intended use includes compliance with the technical data.
- Comply with the technical data for the appliance. Note the information on the rating plate as well as the product identification.
- Note the respective appliance-specific intended use.



*See details on the cover sheet, page 1*

### 4.2 Prevent any potential misuse

#### # Prevent any potential misuse in advance, general

- Do not operate the appliance unsupervised.
- Do not operate the appliance outdoors. Keep the appliance away from moisture.
- Do not operate the appliance in dimly lit places.
- Do not lean against or sit on the appliance.
- Keep any combustible or explosive fluids away from heated appliances. Otherwise a fire or explosion may occur.
- Never operate the appliance with an empty cooking container.
- After 3 hours the total permissible regenerating and keep-warm time according to the health requirements is reached. Comply with the HACCP requirements.
- Do not use to heat up a room.
- Not intended for private domestic use.

#### # Prevent any potential misuse

- Not intended for private domestic use.

### 4.3 Special intended use for appliances with a Ceran® glass surface

---

#### # Avoid foreseeable misuse

-  **WARNING** Danger of electric shock! If the Ceran® glass surface is damaged, if there is a crack in the glass for example, disconnect the appliance from the mains supply immediately. If possible avoid electrically conductive materials in the immediate vicinity, for example metal splash guards.
- With **varithek® 2.0** with Ceran® glass surface, never place a hot pan on the cold Ceran® glass surface or a cold pan on the “hot” Ceran® glass surface, as the Ceran® glass surface could crack due to temperature stress.
- Even a seemingly light object such as a salt cellar can cause cracks or breaks in the Ceran® glass surface in the worst case scenario. Prevent objects from falling onto the Ceran® glass surface.
- Do not place aluminium foil or plastic containers on the Ceran® glass surface, as this could cause damage.

### 4.4 Special intended use for appliances with an induction hob

---

#### # Avoid foreseeable misuse

-  **WARNING** Persons with a pacemaker may experience interference or influence when handling an induction appliance due to electromagnetic radiation. We recommend that the operator takes the following precautions: Keep persons with a pacemaker away from the appliance. Identify this workplace where necessary. Have the doctor clarify the actual situation and individual compatibility where necessary.
- The induction generator could switch off or be damaged. Only use the appliance with induction-compatible and approved cookware. Semi-inductive cookware will result in a decreased cooking performance; the efficiency will be substantially reduced.

### 4.5 Special intended use for appliances with a stainless steel grill area

---

- For frying and braising foodstuffs.
- Never place a plastic container on the stainless steel grill area, as this could cause damage.

### 4.6 Special intended use for appliances with a stainless steel cooling surface

---

- For cooling food.



## 5 General Safety Instructions

This section covers residual risks and hazards associated with the intended use of the appliance. We have provided a list of all generally valid safety instructions which must be followed.

In the following section, safety information relating to a particular operation or situation is placed before the appropriate operation step or description of the situation.

The information provided here such as 'Basic rules of conduct', 'Operator's obligations' etc. only refers to the legally required observance of requirements such as the Workplaces Ordinance (ArbStättV) according to German law.



Observe these operating and safety instructions to prevent injuries, damage to health and damage to property. Refrain from rearranging or changing the device.



Do not use the appliance if damaged. If there are signs of a fault or in the case of unusual noises or smell, switch the appliance off and unplug the mains plug. Only use the appliance with the cable undamaged. Otherwise there is a danger of electric shock and fire.



Maintenance and repair work may only be carried out by qualified and skilled personnel using original spare parts and accessories. Never attempt to carry out repairs to the appliance yourself!



Only connect the appliance to suitable earthed mains connections. Make sure that the mains connection matches the specifications on the type plate of the appliance, see bottom of appliance. Otherwise there is a danger of fire and electric shock!



Place the appliance on a stable, flat and heat-resistant surface, to prevent risk of fire and accidents.



Do not place the cable close to heat sources or on sharp edges etc. Always grasp the plug, not the cable, when removing the plug from the socket. Otherwise the cable may be damaged. Do not allow the cable to hang down. Lay the cable in such a way that it does not represent a tripping hazard!

When using extension cables: Unwind the cable from the cable drum to prevent a possible heat build-up and/or cable fire. The coupling must have splash protection, must be made of rubber or be rubber-coated. The cable cross-section must be at least 1.5 mm<sup>2</sup>.



This appliance is not intended to be used by persons (including children) with limited physical, sensory or mental aptitude or lack of experience and/or knowledge unless they are supervised by a person responsible for their safety or have received instruction from this person as to how the appliance is used. Children should be supervised, to ensure that they do not play with the appliance.



Do not operate the appliance unsupervised. Make sure that the switch is in position "0" and the power regulator is in position "0", before inserting the plug in the socket. Make sure the appliance cannot be switched on unintentionally. Connecting the appliance to the power supply while it is switched on can cause an accident.



Protect the appliance from moisture (splashes, rain). Do not immerse the appliance in water or other liquids, do not wash in the dishwasher. Water penetration increases the risk of an electric shock.



Use only Rieber **thermoplate**<sup>®</sup> as a cooking vessel. Always use a lid for heating food or keeping it warm. The hob and the bottom of the cooking vessel must always be clean and dry. Do not use cooking vessels made of plastic, porcelain or aluminium foil.



Do not block or cover the ventilation slot for aerating and ventilating the appliance. This can lead to overheating of the appliance. Observe a minimum distance of 10 cm from walls or objects. Do not operate the appliance near other heat sources. Do not insert objects into the openings.



Do not touch the hot surface of the glass or adjacent surfaces. The surfaces of the appliance get hot. Please let the appliance cool down completely before cleaning or storing it. Otherwise there is a risk of burns and fire!

**thermoplates®** get hot during use. Wear protective gloves when handling hot **thermoplates®**. Avoid burns.

**⚠ WARNING** When lifting the lid, scalds can be caused by hot steam or condensation water.

Risk of burns from hot food. Check the temperature of the food before serving.



Carefully clean the appliance at regular intervals. Do not use corrosive cleaning agents, hard scouring pads, steel wool or oven spray. You can find special cleaners and cleaning scrapers in shops.



Avoid scratches from pointed and sharp objects on the glass surface. Protect the glass surface from breakage due to falling objects. Place cooking vessels carefully on the glass surface.

Materials such as plastic, aluminium foil or sugar can cause cracks or breaks in the hot glass ceramic.

Switch the heating mechanism off and scrape off the residues with a glass scraper, while the heating surface is still warm.

### # Important information



In addition to this user guide there are a range of health and safety and other regulations that are relevant for operation. When handling food, please observe the HACCP regulations on compliance with hygiene requirements.



Your appliance is made of high-quality material which can be reused / recycled. Take it to a collection point. For disposal, disconnect the appliance from mains supply. Unplug the mains plug. Cut off the cable directly at the casing. Take the appliance and the cable to your municipal waste disposal centre.



#### CAUTION

The total connected load of electrical appliances might exceed the locally permissible connected load. Peak loads can occur, for example, when several appliances are turned on/off simultaneously. Material damage, including cable fire, is possible.

- ▶ Comply with the locally permissible connected load.
- ▶ Avoid switching a large number of appliances on/off at the same time.



#### CAUTION

**thermoplates®** can be damaged by overheating.

- ▶ Please observe the **thermoplate®** instructions.

### # Operator's obligations

Operator: The operator is the person who operates the appliance for commercial or economic purposes either himself/herself or lets others use it and bears the legal appliance responsibility for protection of the user, staff or any third parties during operation.

The appliance is used in commercial applications. For this reason, the operator of the appliance must meet all legal duties relating to work safety.

In addition to the safety instructions in this guide, the safety, accident prevention and environmental protection regulation applying to the application of the appliance must be complied with.

In particular, the following shall apply:

- The operator must be familiar with the applicable work safety regulations and identify, by carrying out a risk analysis, any additional hazards which are due to the place where the appliance is used. These hazards must be addressed in the form of operating instructions governing the operation of the appliance.
- Throughout the period of use of the device the operator must check that the operating instructions which he has compiled comply with the current regulations and adapt them if necessary.
- The operator must define and assign the responsibilities for installation, operation, repair, maintenance and cleaning clearly.
- The operator must ensure that all employees who use the device have read and understood these instructions. In addition, the operator must train the personnel and inform them of the hazards involved at regular intervals.
- The operator must provide the personnel with the necessary protective equipment and issue mandatory instructions on wearing it.

In addition, the operator must ensure that the appliance is always in a perfect technical condition. For this reason, the following shall apply:

- The operator must ensure that the maintenance intervals defined in this guide are obeyed.
- The operator must regularly check all safety devices for functionality and completeness.
- The operator must ensure that the appropriate media connections are present.
- The operator must ensure that structural safety measures are performed.

## 5.1 Personnel qualification requirements

---

Safe operation requires certain technical skills and personal qualification of each person.

- The responsibility for organization lies with the '**Designated Representative**' (operator). According to EN 50110-1 a work supervisor is a person who is appointed to take direct responsibility for the performance of work. If necessary, this responsibility can be assigned partly to other persons. [...] The designated representative must instruct all persons involved in the work on all hazards which may not be obvious for them'.
- The work may only be performed by '**instructed persons**' who have been trained accordingly. Training, instructions must be repeated, proper understanding must be verified (ideally by way of an appropriate test).
- Only '**Qualified Staff**' are allowed to carry out repair work. IEC 60204-1 defines qualified personnel as "persons who, on account of their training and relevant experience are in the position to recognise risks and avoid potentially dangerous situations."
- Electrical work may only be carried out by trained and experienced **electricians**. Electro-technically instructed persons may only work under the supervision of a qualified electrician.

- Any repairs and/or overhaul during the warranty period may only be carried out by the manufacturer's service department.



'Warranty and liability', page 42

## 5.2 Provision of protective equipment for personnel

---

- Ensure that the personnel wear the personal protective equipment appropriate to the relevant situation.
-  Wear safety gloves to avoid burns.

## 5.3 Appliance-specific safety instructions

---

This chapter provides general safety information about devices from this modular series of products. In the following section, additional safety information relating to a particular operation or situation is placed before the appropriate operation step or description of the situation.

### 5.3.1 Safety and monitoring devices

- The appliance is protected against overheating. In the case of a defective control, the maximum admissible temperature is kept.
-  In addition to protection against electric shock and in order to ensure that the frames of electrical equipment and any external conductive components are at an equal (or practically equal) potential, the appliance must be connected to the potential equalisation system. The connection of all conductive bodies (housing) of electrical equipment to an earthed protective conductor and the main earthing bar is the basic principle for protection against electric shock.
- To increase your safety we recommend that you install a residual current device with a tripping current of 30 mA upstream of the appliance.
- Only connect the appliance to a switched mains socket, so that the power supply can be interrupted in case of emergency.
- The appliance has an indicator light for 'Switched ON/OFF' operating status, which lights up green when the appliance is switched on. Does not apply to type 'ck-2200'.

#### # Safety and monitoring devices for 'ck-2200'

- After 3 hours the total permissible regenerating and keep-warm time according to the health requirements is reached.

 The LED flashes red after 3 hours of continuous operation.



page 28

### 5.3.2 Risks from hot surfaces, burns and explosion

---



#### WARNING



In the area of hot parts such as hob, containers and food, there is a risk of burning one's hands and arms on the hot surfaces. The state of the hot heating surface is not visible.

- ▶ Where possible wear protective gloves.
  - ▶ Keep unauthorised persons away from the appliance.
  - ▶ Never operate the appliance unsupervised.
  - ▶ Keep flammable materials away from the product.
- 



#### WARNING

Risk of explosion due to overheated oil or fat.

- ▶ Never quench burning grills / frying surfaces with water, as this would create a risk of explosion.
  - ▶ Smother the flames with a large pan lid, plate or damp cloth.
- 

### 5.3.3 Dangers due to unexpected heating of objects as a result of induction

---



#### WARNING

Risk of burns when wearing metal parts on the body in close proximity to an induction appliance close to the surface of the cooking area.

- ▶ Do not wear watches, rings or metal objects.
  - ▶ Do not place metal objects such as cutlery, tins or jewellery on the hob within the cooking zone.
- 



#### CAUTION

Substantial damage is possible to magnetically-sensitive objects in close proximity to an induction appliance.

- ▶ Keep magnetically-sensitive objects such as credit cards, phone cards, cassettes and watches away from the area immediately around an induction appliance.

### 5.3.4 Danger for persons with pacemakers due to induction

---



#### WARNING!

Risk of death. Persons with a pacemaker may experience interference or influence when handling an induction appliance due to electromagnetic radiation.



We recommend that the operator takes the following precautions:

- ▶ Keep persons with a pacemaker away from the appliance initially. Identify this workplace where necessary.
  - ▶ Have the doctor clarify the actual situation and individual compatibility where necessary.
- 

### 5.3.5 Danger of electric shock

#### ⚠ Electrical hazards

---



#### WARNING

Danger of electric shock. Water penetration increases the risk of an electric shock.

- ▶ Never direct a water jet onto the device.
  - ▶ Protect the appliance from moisture.
- 

#### ⚠ Risks arising from damaged Ceran® glass surface

---



#### WARNING

Risk of electric shock from damaged Ceran® glass surface cannot be excluded.

- ▶ Avoid electrically conductive materials in the immediate vicinity, for example metal splash guard.
  - ▶ If the Ceran® glass surface is damaged, if it is cracked, for example, disconnect the appliance from the mains supply immediately.
- 



See 'Troubleshooting' chapter, page 41



### CAUTION

Improper handling and impacts can damage the Ceran® glass surface.

- ▶ **NEVER** place a hot pot on the cold Ceran® glass surface or a cold pot on a hot Ceran® glass surface, otherwise the Ceran® glass surface may crack due to thermal stresses.
- ▶ Do not place inappropriately large or heavy pots or objects on the appliance. Avoid falling objects.
- ▶ Even seemingly light objects, like a salt cellar, can cause cracks or breaks in the worst case scenario. Prevent objects from falling on the Ceran® glass surface.
- ▶ Materials such as plastic, aluminium foil or sugar can cause cracks or breaks as well as incrustations and adhesions on the hot Ceran® glass surface. Switch the heating mechanism off and scrape off the residues with a glass scraper, while the heating surface is still warm.

### 5.3.6 Danger of cuts from damaged Ceran® glass surface



### WARNING

Danger of cuts from damaged Ceran® glass surface. Sharp edges can cause severe cuts.

- ▶ If the Ceran® glass surface is damaged, disconnect the appliance from the mains supply immediately.
- ▶ Take the necessary measures.

### 5.3.7 Note the product identification and ensure its preservation

- The type plate bears the legally required product data.
- Brief instructions on use
-  Unplug the mains plug before opening or cleaning the appliance.



Equipotential bonding on the underside of the appliance. Note the symbol.

## 5.4 Information about regulations to be followed

In addition to this user guide there are a range of health and safety and other regulations that are relevant for the operation of this cooking station; these include HACCP food hygiene regulations for example.

### 5.5 What to do in an emergency

---

- In an emergency the power supply must be cut off immediately.

#### # First aid in the event of burns and scalding or electric shock:

- Inform yourself on this before commissioning the appliance.
- Store the emergency equipment, including the relevant instructions, at a readily accessible place near the place of use.



#### User tip

- ▶ You can find detailed information in the company's internal instructions.
- ▶ We recommend that half-yearly emergency training sessions should be carried out.

## 6 Before First Use

This chapter provides information about preparations that have to be made before using the device.

#### # Check/deal with any transport damage

- Immediately after delivery, visually check the appliance for any transport damage.
- Document any potential transport damage on the consignment note in the presence of the haulage contractor. Have the damage confirmed by the haulage contractor (with signature).
- Decide if you wish to keep the appliance and report the defect using the consignment note, or if you wish to reject the appliance.

■ By following this procedure you will ensure proper claim settlement.

#### # Unpacking

- Open the transport packaging at the positions provided for this purpose. Do not tear or cut.
- Remove any packaging remnants.

#### # Scope of delivery

- Check the scope of delivery.

#### # Dispose of packaging material

- Dispose of packaging material in a proper and environmentally compatible manner.

#### # Clean the appliance

- Clean the appliance if necessary before using for the first time.



See chapter 'Cleaning, maintenance and care', page 37



## 7 Safety instructions for commissioning /recommissioning

### Observe the general prerequisites

- The appliance has no defects or visible damage.
- The appliance is at room temperature and is dry.





### CAUTION

Protective foils or heat-sensitive objects at/in the appliance might damage the appliance during heating.

- ▶ Ensure that there is no protective foil on/in the appliance.

- Comply with the installation conditions, such as adequate lighting, stable positioning, free access. The place of installation is horizontal.

-  **WARNING** Risk of fire. Observe a minimum distance of 20 cm from walls. When setting up this appliance close to a wall, separating wall, kitchen furniture, decorative casing, etc., we recommend ensuring that these are not made of flammable materials. Failing this, they must be clad with suitable, non-combustible, heat-insulating material. The fire safety regulations must be observed.

-  **WARNING** Only operate the appliance with a power socket that can be disconnected. Install a ground fault circuit interrupter with a trigger current of 30 mA upstream.



*Observe the chapter 'Intended use, page 15*

### Special instructions for the installation of varithek® 2.0 gp-3400-SP

- Ensure adequate ventilation. An extractor fan is required at the place of installation.

### Observe the local building inspectorate regulations

- Get information from the local authorities.

### Comply with applicable electrical regulations



### WARNING

Danger of electric shock. Dangerous electrical voltage. The total connected load of electrical appliances might exceed the locally permissible connected load.

- ▶ Have electrical work carried out by the manufacturer, its customer service or a qualified electrician only.
- ▶ Only connect the appliance via a residual current operated device (RCD). Connect the appliance to a power socket with protective contact.
- ▶ Peak loads can occur, for example, when several appliances are turned on/off simultaneously. Material damage, including cable fire, is possible. Comply with the locally permissible connected load. Avoid switching a large number of appliances on/off at the same time.









Equipotential bonding must be carried out by a qualified electrician.

## 8 Use

### 8.1 Safety information with regard to use

#### **Keep to the basic rules for operating the product**

-  **WARNING** Danger of electric shock! If the mains cable is damaged, switch off and lock the appliance immediately. Repair.
-  **WARNING** Danger of cuts from damaged Ceran® glass surface.
-  **WARNING** Keep unauthorised persons away from the appliance. Never operate the appliance unsupervised.
-  **WARNING** Risk of burns! Risk of fire! NEVER pour oil or fat into an empty, heated pot or pan.
-  **WARNING** Risk of explosion due to overheated oil or fat. Smother the flames with a large pan lid, plate or damp cloth.
-  **WARNING** Risk of fire due to excessively soiled or missing grease filter.
- Never use the appliance as a storage surface.
- Keep aluminium foil and plastic containers away from the heating surface.
-  **WARNING** In the event of a power failure always switch off the switch of the mains socket outlet, otherwise the appliance could suddenly restart and cause unforeseen risks.
- Observe the indicator light for 'Switched ON/OFF' operating status and the operation indicator light etc..

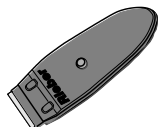

- Remove stubborn dirt from the Ceran® glass surface immediately if possible, using the **glass scraper**.

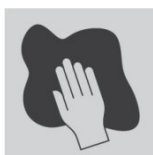





- Light dirt that is not burnt on can be removed with a **damp cloth** or a washing-up sponge **without detergent**.



See '*Cleaning, maintenance and care*' chapter, page 37

#### **# Observe certain prerequisites for appliances with inductive heat generation**

-  **WARNING** Risk of burns! Keep metal objects such as watches, rings, cutlery and tins away from the cooking zone. These could be heated up very quickly.
- Only use induction-compatible containers for the induction cooking appliance. Use GN containers, pots and pans.
  -  Unsuitable equipment can damage the appliance.
  -  If unsuitable equipment is used, no power is output.
  -  The use of combined types of cooking equipment (semi-inductive cookware) decreases efficiency.

- Always place the induction-compatible cooking container centrally on the induction hob:
  - The cooking container is heated evenly.
- Keep magnetically-sensitive objects such as credit cards and phone cards away. Such objects could be damaged.

## 8.2 General mode of operation

### 8.2.1 Start process

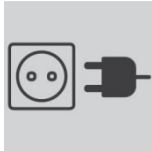

- Connect appliance to power.

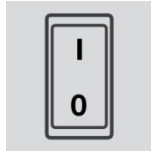

- Switch on the switch of the mains socket outlet.

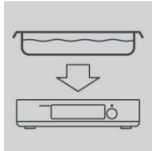

- **thermoplate®** on the appliance.

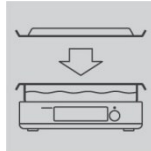

- Put lid on.

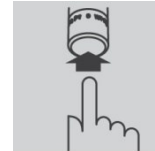

- Press the retractable power regulator.



- Select the desired power setting.

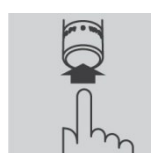

- Press and retract power regulator.

■ The selected program is executed.

- If the power supply is interrupted during the program sequence, the program must be restarted.

### 8.2.2 Stop process

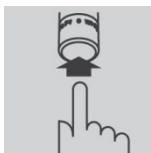

- Press the retractable power regulator.



- Turn the power regulator to '0'.
  - The indicator light will be off.

### 8.2.3 Switch appliance off



➤ Press the retractable Power regulator .



➤ Turn the power regulator to '0'.



➤ Press the retractable power regulator.

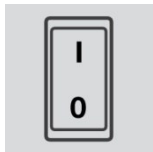

➤ Switch off the switch of the mains socket outlet.

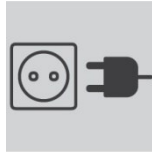

➤ Unplug the connector from the mains socket outlet.

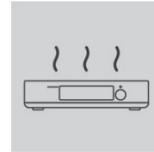

➤ Allow appliance to cool down.

## 8.3 ch-800

### # Intended use of varithek® 2.0 ch-800

- For keeping ready-to-eat hot dishes warm.
- Retractable dial with ON/OFF switch ,infinitely variable, marked from 0 to 9.



'Purpose', cover sheet page 1, page 15 ff.

## 8.4 ck-2200

### # Intended use of varithek® 2.0 ck-2200

- **Keep-warm settings 1 to 3:** ⇨ For keeping ready-to-eat hot dishes warm.
- **Programs P1 to P6:** ⇨ For automatic regeneration of pre-prepared dishes.
- **Power settings 4 to 6:** ⇨ For steaming, cooking and baking.



'Purpose', cover sheet page 1, page 15 ff.

									für Gebrauch von thermoplates		
									immer Deckel benutzen		
<b>P1 - P6:</b> ● - gelb gelb rot arbeitet    fertig    > 3 Stunden - kein HACCP			<b>W1 - W3 / 4 - 6:</b> ● - rot rot arbeitet    > 3 Stunden - kein HACCP			in keine Flüssigkeiten eintauchen					
P1 - P6: definierte Programme zur Essensregeneration / W1 - W3: Warmhalten von Essen / 4 - 6: optionale Kochstufen											

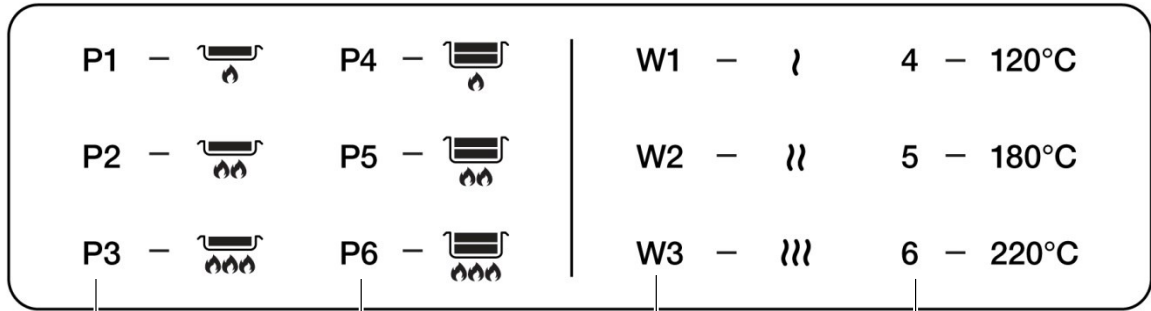

Initial temperature  
4 ° to 6 °C

Program settings  
for regenerating  
small quantities

Initial temperature  
4 ° to 6 °C

Program settings  
for regenerating  
large quantities.

Initial temperature  
65 ° to 70 °C

Program settings  
for keeping warm

Power settings

For cooking, baking and  
grilling freshly prepared  
meals

### # Program settings for keeping warm

Program setting	for keeping food warm	Medium power
<b>W1</b> - }	for delicate dishes	300 W
<b>W2</b> - }}	for less delicate dishes	440 W
<b>W3</b> - }}}	for robust dishes	650 W

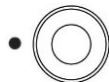





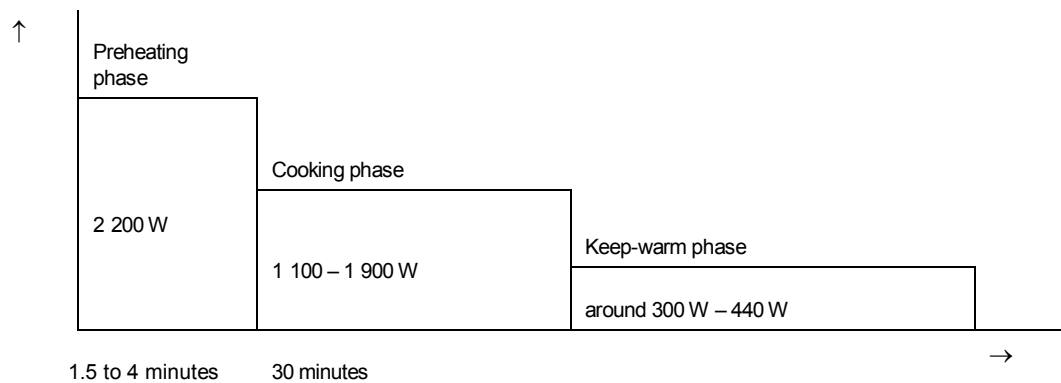

The LED lights up red during the keep-warm time.

### # Program settings for regeneration

Automatic regeneration of pre-prepared food



Program setting		For heating / regenerating food. For example	Medium power
P1	— 	Food with delicate structure such as fish, rice, couscous, pasta	1 100 W
P2	— 	Delicate vegetable dishes such as chard, asparagus, hop shoots, sugar snap peas	1 220 W
P3	— 	Less delicate vegetable dishes such as puree, polenta, root vegetables, beans, cauliflower, carrots	1 400 W
P4	— 	Thai curry, light vegetable stews, Züricher Geschnätzelttes (Zurich-style veal dish), rice, pasta, couscous, puree	1 550 W
P5	— 	Casseroles, ragouts, compact stews containing meat	1 700 W
P6	— 	Casseroles, ragout	1 870 W



After 35 minutes the appliance automatically switches to the keep-warm phase.

 The LED flashes yellow.

 Change to the keep-warm phase

### # Power settings for cooking

Power setting	for:	Power:
4 — 120°C	Steaming	1 100 W
5 — 180°C	Cooking and baking	1 450 W
6 — 220°C	Baking	2 200 W

- After 3 hours the total permissible regenerating and keep-warm time according to the health requirements is reached.

 The LED flashes red after 3 hours of continuous operation.



### CAUTION

**thermoplate®** can be damaged by overheating.

▶ Please observe the instructions for your **thermoplate®**.

## 8.5 ck-2800

### # Intended use of varithek® 2.0 ck-2800

- For keeping ready-to-eat hot dishes warm.
- For cooking
- Retractable dial with ON/OFF switch, infinitely variable, marked from 0 to 9.



*'Purpose', cover sheet page 1, page 15 ff.*

## 8.6 ck-3400-2Z-o

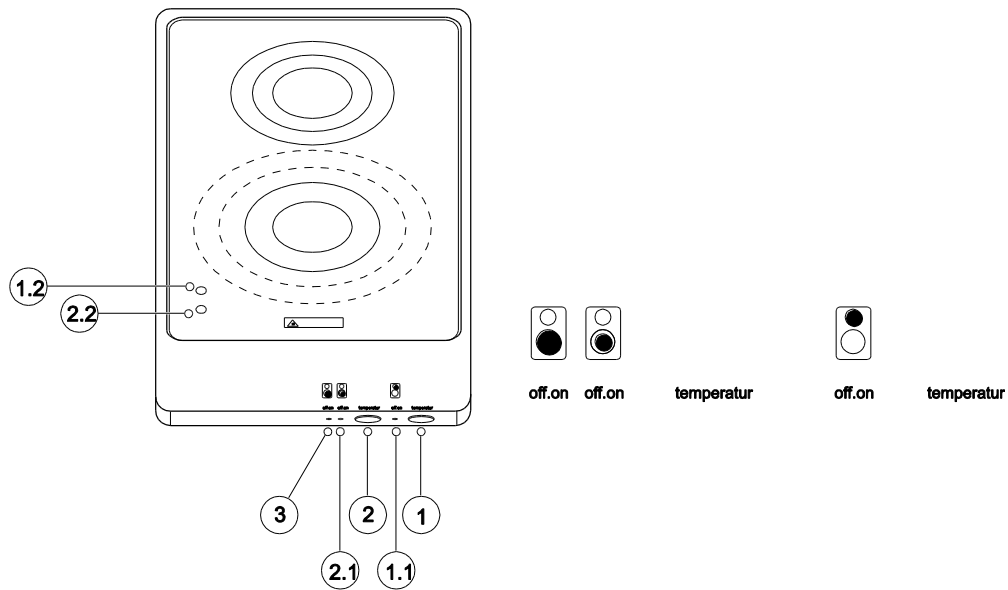

- |   |   |
|---|---|
| <p>1 Retractable and infinitely variable power regulator, settings 0 to 9, <b>rear</b> heating surface; and ON/OFF switch</p> <p>1.1 Indicator light for 'Switched ON/OFF' operating status, lights up GREEN during heating, <b>rear</b> Heating surface</p> <p>1.2 Indicator light for 'hot surface' residual heat indicator, lights up RED, <b>rear</b> heating surface</p> | <p>2 Retractable and infinitely variable power regulator, settings 0 to 9, <b>front</b> heating surface; and ON/OFF switch</p> <p>2.1 Indicator light for 'Switched ON/OFF' operating status, lights up GREEN during heating, <b>front</b> heating surface</p> <p>2.2 Indicator light for 'hot surface' residual heat indicator, lights up RED, <b>front</b> heating surface</p> <p>3 Indicator light for outer front heating surface, lights up YELLOW</p> |
|---|---|

### # Note on using the front hob with 2 cooking zones

Turn the power regulator clockwise to increase the power, or anticlockwise to decrease it.

- Turn the power regulator (2) clockwise to activate the **inner front cooking zone**.
- By turning the power regulator (2) clockwise as far as the stop and slightly past, the **outer front cooking zone** is also activated.
- To switch off the front cooking zone, turn the power regulator (2) to setting '0'.



### User tip

- ▶ Place the pot or pan in the centre of the Ceran® glass surface.
  - The pot/pan base is evenly heated.

## 8.7 ik-3500, ik-3500-o

---

### # Intended use

- For keeping ready-to-eat hot dishes warm.
- For cooking
- Retractable dial with ON/OFF switch ,infinitely variable, marked from 0 to 9.



*'Purpose', cover sheet page 1, page 15 ff.*

### ⚠ Observe the special safety requirements



*page 26*

- **⚠ WARNING** Risk of fire due to excessively soiled or missing grease filter. Make sure that the grease filter is clean, dry and properly inserted.

### # Note on use

- Place the induction-compatible cooking container centrally on the hob. Observe the minimum pot diameter of  $\geq 120$  mm.

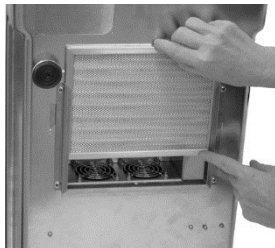



## 8.8 ik-3600-2Z-□

### 8.8.1 Overview of functions

Pot detection	X
Power settings	X
Melting and keep-warm function	X
Automatic preheating	X
Boost function	X
Bridging function	X
Automatic shut-off (operating time limitation)	X

#### 8.8.1.1 Pot detection (induction)

- The heat setting of a cooking zone can be selected without any cookware present.
- The power is generally only released by the control when suitable cookware is detected on the cooking zone. Make sure that you use suitable cookware.
- **If no pot is detected, the appliance control switches the cooking zone off** after 10 minutes. The cooking zone can only be switched on again when the power regulator has been turned back to the "0" position.
- Minimum pot diameter: 120 mm

#### 8.8.1.2 Power settings

- Power settings 1 to 9 enable any type of food preparation, from gently keeping warm and regeneration to grilling.

#### 8.8.1.3 Melting and keep-warm function

##### # Melting function

**The purpose** of the melting function is to regulate the **base of the pot to give a temperature of around 45 °C /42 °C in the pot**. This allows food to be melted in an energy-optimised manner.

- The melting function is **setting 1**, which is reached by turning the power regulator to the right from the zero position.
- The maximum period of time is **limited to 2 hours**. Switches to OFF automatically.

##### # Keep-warm function

**The purpose** of the keep-warm function is to regulate the **base of the pot to give a temperature of around 70 °C /65 °C in the pot**. This allows food to be kept warm in an energy-optimised manner or gently warmed.

- The keep-warm function is **setting 2**, which is reached by turning the power regulator to the right from the zero position.
- The maximum period of time is **limited to 2 hours**. Switches to OFF automatically.

#### 8.8.1.4 Automatic preheating

The **purpose** of the automatic preheating is to trigger the following heat setting.

- This function is activated by **fully turning** the power regulator **to the left** with a **holding time of at least 2 seconds**. **A heat setting must be selected** on the **power regulator** within 10 seconds, the so-called continuous **cooking setting**.
- If heat settings 0, 1, 2, 9 are selected or if the power regulator is turned all the way to the left/right, then the automatic preheating is not activated.

#### 8.8.1.5 Boost function

- With the boost function you can set a time limit, a **maximum of 10 minutes**, for operating a cooking zone at maximum power.
- If both hobs are selected in the booster function, then the last selection takes priority. The other cooking zone is automatically reduced to half power. The maximum possible power of the appliance is constant.
- **To activate this function**, turn the power regulator to setting 8, then to setting 9 as far as the stop.  
Then set the power regulator to setting 8.
- **To deactivate the function**, turn the power regulator anticlockwise to a setting below 8.  
█ After 10 minutes the function switches off automatically.

#### 8.8.1.6 Bridging function

- On the induction hob, two defined cooking zones can be "bridged". These can be controlled as if they were "one" cooking zone.
- The left cooking zone is the main cooking zone. The right cooking zone is the additional cooking zone.
- **The power regulator of both cooking zones must be turned all the way to the right** simultaneously. **Minimum holding time 2 seconds**. The **power regulator** of the **additional cooking zone** must then be set to **heat setting 9**.

#### 8.8.1.7 Automatic shut-off (operating time limitation OTL)

- Depending on the heat setting selected for each cooking zone, a maximum permissible operating time (without any changes in heat setting) is defined.
- If this maximum time limit is exceeded, the respective cooking zone is switched off.
- The cooking zone can only be restarted after resetting ("zero setting") the power regulator.
- The time remaining until automatic shut-off is reset to the initial value after each new operation of the cooking zone.

Heat setting:	OTL [minutes]:	Heat setting:	OTL [minutes]:
1	120	5	300
2	120	6	300
3	360	7	240
4	360	8	90

### 8.8.2 Intended use of ik-3600-2Z-□

- For keeping ready-to-eat hot dishes warm.
- For cooking, grilling



*'Purpose', cover sheet page 1, page 15 ff.*

### 8.8.3 Instructions for use

#### **Observe the special safety requirements**



*page 26*

Suitable for induction-compatible GN containers of sizes 1/1, 2/3, 1/2, 1/3 as well as pots and pans with a diameter of around 22 cm. Observe the minimum pot diameter of  $\geq 120$  mm.

- Left power regulator for front hob.
- Right power regulator for rear hob.

#### **# Note on use**

- Turn both power regulators to the '0' position when switching on the appliance.
- Wait for at least 3 seconds. Then set the power regulator to the desired power.

**|** When the cooking container is removed from the hob, the power of the appliance reduces automatically due to the absence of inductive heating.



#### **User tip**

- ▶ Use **thermoplate**<sup>®</sup>, the coated **swiss-ply thermoplate**<sup>®</sup> in GN format with or without a handle, and Demeyère pots and pans.

## 8.9 gp-3400-SP

---

### # Intended use

- For keeping ready-to-eat hot dishes warm.
- For cooking, grilling



*'Purpose', cover sheet page 1, page 15 ff.*

### Observe the special safety requirements



*page 26*

-  **WARNING** Risk of fire. Make sure that the grease drip tray is fitted on the bottom.
- Only use tools recommended for this purpose.

### # Note on use

- Infinitely adjustable with power regulator.  
Temperature adjustable from +50 °C to +250 °C.
- Grease drainage via grease drain pipe

## 8.10 Accessories and their use

---



### User tip

With the right accessories, **varithek® 2.0** is energy-saving, and the appliance can be used for a wider range of applications.

- ▶ Use accessories from Rieber.



*Page 12 et seqq.*

## 9 Cleaning, maintenance and care

This chapter will help you to meet the hygiene requirements. Before reading this section, please read through the "General safety instructions" section thoroughly first.

### 9.1 Safety information relating to cleaning, maintenance and care

#### ⚠ Avoid dangers due to hot parts or areas



#### WARNING

In the area of hot parts such as hob, containers and food, there is a risk of burning one's hands and arms. The state of the hot heating surface is not visible.



- ▶ Where possible wear protective gloves.
- ▶ Keep unauthorised persons away from the appliance.
- ▶ Allow the device to cool down.

The surface of the appliance cools down to lukewarm within 60 minutes with the heating surface open.

#### ⚠ Avoid dangers due to electricity



#### DANGER

Danger of electric shock. Risk of death.

- ▶ Isolate appliance from power supply; disconnect the power supply unit.
- ▶ Protect the appliance from moisture. Never direct a water jet onto the device. Do not use a steam cleaning unit to clean the appliance. Doing so may allow moisture to get into the electrical system and cause a short circuit.
- ▶ Have electrical appliances inspected by a qualified electrician **every six months**<sup>2</sup>.

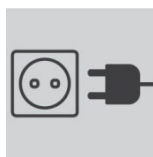

- Unplug the connector from the mains socket outlet.

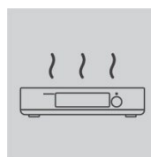

- Allow appliance to cool down.



- Clean the appliance.

<sup>2</sup> Source: DGUV Regulation 3. Electrical Systems and Equipment

## 9.2 Choose the correct cleaning method

---

In principle the same rules apply for cleaning Ceran® glass surfaces as for standard glass surfaces.

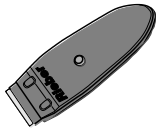

- Remove stubborn dirt from the Ceran® glass surface immediately if possible, using the **glass scraper**.



- Light dirt that is not burnt on can be removed with a **damp cloth** or a washing-up sponge **without detergent**.
- **NOTE.** Clean the **cooled** hob with **commercially available glass cleaner**.
- Wipe down the surfaces afterwards with a **soft cloth**.



### CAUTION

Incorrect cleaning can damage the surface or even destroy the appliance.

- ▶ Be careful not to scratch the surface with sharp-edged objects. Do not use sponges with a scratchy surface or steel wool or a steel brush.
- ▶ Do not use scouring agents or aggressive cleaning agents, such as oven sprays.
- ▶ Do not mix standard cleaning agents; do not produce your own cleaning agent.
- ▶ Avoid extended exposure of stainless steel to liquid containing salt, as this can lead to surface discolouration and corrosion.
- ▶ Avoid direct, extended contact of stainless steel with corroding iron parts, e.g. steel kitchen sponge.

## 9.3 Clean and service stainless steel parts

---



### CAUTION

Incorrect cleaning can cause damage to the surface.

- ▶ Clean the appliance with a **mild detergent diluted in hot water**. After cleaning, rub surfaces dry with a **soft cloth**.



### User tip

- ▶ We recommend Rieber cleaning agent for stainless steel for cleaning stainless steel.  
| It is an especially thorough yet gentle cleaner, produces a dazzling shine, and cleans and protects in one.

## 9.4 Clean and service plastic parts

---



### CAUTION

Incorrect cleaning can cause damage to the surface.

- ▶ Clean the appliance with a **mild detergent diluted in hot water**. After cleaning, rub surfaces dry with a **soft cloth**.

## 9.5 Clean grease filter, grease drip tray

---

These parts are suitable for cleaning in the dishwasher.



### WARNING

Risk of fire. Separated greases and oils may ignite.

- ▶ Clean grease filter, grease drip tray.
- ▶ Fit grease filter correctly. Do not use third-party brands.

The cleaning interval depends on how frequently the appliance is used and the grease load! We recommend cleaning the appliance at least weekly.



### CAUTION

An excessively soiled grease filter can damage the appliance. This also applies for a missing filter as well as third-party brands. Overheating of the generator is possible. Water residues in the grease filter can be sucked into the electronics and damage them.

- ▶ Dry the grease filter thoroughly after cleaning.

## 9.6 Clean the ventilation grille

---

The ventilation area is located on the bottom of the appliance.



### WARNING

Risk of fire. Fluff in the ventilation area can cause a build-up of heat which could result in a fire.

- ▶ Clean the ventilation grille at least once a month with a cloth, brush or vacuum cleaner.

## 9.7 hp-SP, hp-SP-E

---

### # Defrost and clean the appliance



#### User tip

When defrosting a heavily iced-up cooling surface, the defrosted liquid runs down on all side of the appliance. This may be undesirable.

- ▶ Turn the appliance onto the long or short side during defrosting if necessary.
- ▶ Then clean the stainless steel parts.

### # Have coolant filling level checked



#### User tip

The cooling compartment can lose refrigerant. Loss of coolant can cause reduced refrigerating capacity and damage the cooling unit.

- ▶ The manufacturer recommends yearly inspection by a refrigeration expert.

- ▶  **WARNING** Refrigerant is harmful to health. Handling refrigerant is only permitted by an expert, such as a refrigeration expert.

## 9.8 Ensure preservation of the product identification

---

The type plate provides important technical data for use and a unique identification, which is necessary for replacement parts, for example. Instructions assist safe handling.

- ▶ Double check the condition of the product identification. Inspect this at least 1x every six months. Contact 'Sales & Service' if necessary.



*'Note the product identification and ensure its preservation', page 23*

## 9.9 Keep ready for next use in dry condition

---



#### CAUTION

Incorrect storage can damage the appliance.

- ▶ Do not stack appliances.
- ▶ Store appliance at room temperature.



10 Troubleshooting



**DANGER**

Danger of electric shock. Dangerous electrical voltage.

- ▶ Switch off and lock the defective appliance immediately.
- ▶ Disconnect the connecting plug on the unit before starting repair work.
- ▶ Have all electrical repairs carried out by an authorised electrician only.

- Work on the cooling unit should only be carried out by authorised skilled personnel like a refrigeration specialist or a member of the Rieber Customer Service.  
Applies to type: **hp**

Fault	Possible cause	Rectification
Appliance does not heat up, indicator light does not illuminate	Appliance defective Electrical connector / electrical cable defective Switch on mains socket outlet not switched on. No electrical current	<ul style="list-style-type: none"> <li>➤ Check switch position on the mains socket outlet.</li> <li>➤ Check fuse.</li> <li>➤ Check plug connection.</li> <li>➤ Call Rieber Service or contractual partner</li> </ul>
Inadequate heating power	Appliance defective	<ul style="list-style-type: none"> <li>➤ Repair</li> <li># Rieber Service or authorized partner</li> </ul>
The casing is excessively hot	Appliance defective	<ul style="list-style-type: none"> <li>➤ Repair</li> <li># Rieber Service or authorized partner</li> </ul>
Ceran® glass surface damaged, for example crack	Mechanical impact	<ul style="list-style-type: none"> <li>➤ Repair</li> <li># Rieber Service or authorized partner</li> </ul>
Refrigerating capacity reduced for type hp	Loss of refrigerant	<ul style="list-style-type: none"> <li>➤  <b>WARNING</b> Refrigerant can be harmful to health. Check status.</li> <li># Refrigeration expert</li> </ul>
Connection line or connector plug damaged	Mechanical impact; appliance defective	<ul style="list-style-type: none"> <li>➤ Repair</li> <li># Qualified electrician</li> </ul>

# Customer service, spare parts



**IMPORTANT**

Customer service needs information about the type and number of your appliance.

- If you have a fault you cannot remedy yourself, please get in touch with your Rieber partner or Rieber central customer service.

### # Disposing of your product



Your device is made of high-quality materials that can be re-used or recycled. For disposal, disconnect the appliance from mains supply. Unplug the mains plug. Cut off the cable directly at the casing. Dispose of this appliance properly via your local disposal facility.

## 11 Warranty and liability

Manufacturer liability and warranty shall no longer apply if

- you do not follow the information and instructions in this user guide,
- do not use the device as it is intended,



*See chapter 'Intended use'*

- make conversions or functional modifications,
- do not use original spare parts.

The "Sales and delivery terms and conditions" of Rieber GmbH & Co. KG shall apply for all warranty claims made against the manufacturer. For instance, any repairs and/or overhaul during the warranty period may only be performed by the Rieber service department, failing which any resulting claims may be voided. Please contact the Rieber service department.

**NOTE:** If the product identification is damaged or illegible, the warranty will be invalidated. Contact Rieber Service as early as possible in the event of damage.

The following wear parts are not included in the warranty:

- not applicable

## 12 Excerpt from EC Declarations of Conformity

### EC Declaration of Conformity in accordance with EC Machinery Directive 2006/42/EC

- Rieber GmbH & Co. KG hereby declares that the products **varithek® 2.0**

complies with the basic requirements of the EC Machinery Directive 2006/42/EC, Appendix II A, harmonised standards (DIN EN ISO 12100: Safety of Machinery — General principles for design — Risk assessment and risk minimisation).

### EU Declaration of Conformity in accordance with the European Directive on Electromagnetic Compatibility 2014/30/EU.

- Rieber GmbH & Co. KG hereby declares that the products **varithek® 2.0**

comply with the basic requirements of the European Directive on Electromagnetic Compatibility 2014/30/EU in respect of their electrical design.

If required, a copy of the EC Declaration of Conformity can be obtained from our sales team.

## 13 Index

2 cooking zones.....	31	ik-3600-2Z-□.....	1, 11, 33, 35
Accessories.....	36	Indicator light for operating status.....	31
Automatic shut-off.....	34	Indicator light for outer front heating surface.....	31
Baking.....	28, 29, 30	Indicator light for residual heat indicator.....	31
Boost Function.....	33, 34	Induction.....	11, 21, 22
Built-in system modules.....	14	Induction cooking appliance.....	26
Ceran hob.....	13	Induction hob.....	6, 8, 11, 16, 27
Ceran® glass surface.....	6, 7, 8, 16, 22, 23, 26	Initial temperature.....	29
ch-800.....	1, 11, 13, 14, 28	Keeping warm.....	17, 28, 29
ck-2200.....	1, 11, 20, 28	Keep-warm phase.....	29, 30
ck-2800.....	1, 11, 30	LED.....	20, 29, 30
ck-3400-2Z-o.....	1, 11, 31	ON/OFF switch.....	7, 8, 9, 10, 28, 30, 31, 32
Cleaning.....	19, 23, 24, 26, 37, 38, 39	OTL.....	34
Cooking.....	12, 28, 29, 30	Pacemaker.....	16, 22
Coolant.....	40	Power regulator.....	7, 8, 9, 10, 28, 31, 35, 36
Cooling surface.....	9, 10, 16	Power setting.....	27, 30
Defrost.....	40	Power supply.....	17, 27
Electric hob.....	11	Product.....	23, 40
Equipotential bonding.....	12, 15, 23, 25	Product identification.....	15, 40
Front hob.....	31	Program setting.....	29, 30
gp-3 400-SP.....	1, 11, 25, 36	Regeneration.....	28, 29, 30
Grease drip tray.....	39	Retractable dial.....	28, 30, 32
Grease filter.....	8, 32, 39	Stainless steel.....	8, 13, 16, 38
Grill.....	11	Steaming.....	28
Grilling.....	28	Switch off.....	28
hp-SP.....	1, 9, 11, 40	Switch on.....	27
hp-SP-E.....	1, 10, 40	table-top system module.....	13
ik-3500.....	1, 11, 32	thermoplate®.....	12, 13, 14, 30, 35
ik-3500-o.....	1, 11, 32	Troubleshooting.....	41

## 14 Manufacturer's address

Rieber GmbH & Co. KG  
Hoffmannstraße 44  
D 72770 Reutlingen  
Phone +49 (0) 7121 518-0  
FAX +49 (0) 7121 518-302  
Email [info@rieber.de](mailto:info@rieber.de)  
[www.rieber.de](http://www.rieber.de)